

FOS

CA

RINI

FOSCARINI

Collezioni
Edizione — 6

33 designers, 26
materials, 56 finishes,
24 technologies, 44
colours, 63 lamp
families, 227 different
models.

**/FOSCARINI IMMAGINA,
SVILUPPA E PRODUCE
LAMPADRE DECORATIVE
CONCEPITE COME
OGGETTI DI DESIGN
CHE TRASFORMANO GLI
SPAZI DI VITA: NOTTE E
GIORNO, SEDUCONO – SE
ACCESE; SORPRENDONO –
QUANDO SPENTE.**

***/FOSCARINI IMAGINES,
DEVELOPS, AND
PRODUCES DECORATIVE
LAMPS CONCEIVED AS
DESIGN OBJECTS THAT
TRANSFORM SPACES:
NIGHT AND DAY, WHETHER
THEY'RE ON OR OFF,
THEY SEDUCE, SURPRISE,
AND INSPIRE.***

Indice / Index

- 016 Tavolo
Table
- 096 Terra
Floor
- 152 Sospensione
Suspension
- 260 Accessori
Accessories
- 272 Soffitto
Ceiling
- 304 Parete
Wall
- 360 Esterno
Outdoor

005

Clicca per visualizzare l'indice di categoria
Click to open the category index

Indice generale Terra / Floor

016

Clicca sull'immagine per aprire la pagina di dettaglio
Click on the image to open the product details page

Indice — Table lamps

018 Anisha	058 Light Bulb
020 Biric	060 Lumiere
022 Birdie	062 Lumiere Nuances
024 Birdie Easy	068 Lumiere 30"
026 Birdie Zero	072 Lumiere XX
028 Bridge	074 Madro
030 Budd	076 Magneto
036 Caboché Plus	078 Nile
038 Chapeaux	082 Plass
044 Filo	084 Poly Gregg
046 Fleur	086 Rituals
050 Gem	092 Satellight
052 Gegg	094 Soffio
056 Karage	

017

Clicca sul nome prodotto per aprire la pagina di dettaglio
Click on the name to open the product details page

016 Tavolo
Table

096 Terra
Floor

152 Sospensione
Suspension

260 Accessori
Accessories

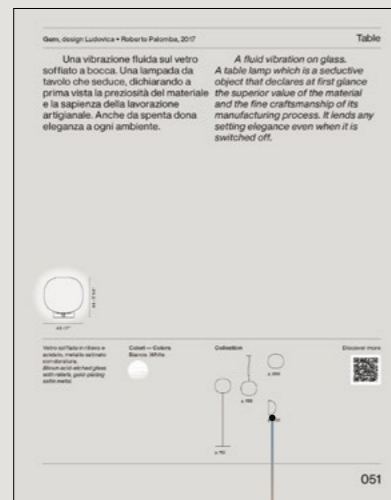
272 Soffitto
Ceiling

304 Parete
Wall

360 Esterno
Outdoor



Clicca sul titolo per visualizzare il prodotto su [foscarini.com](https://www.foscarini.com)
Click on the title to open the product page on [foscarini.com](https://www.foscarini.com)







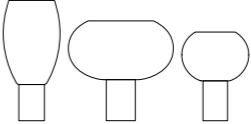
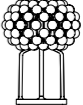
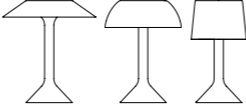


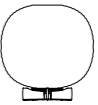

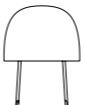


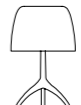
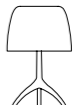
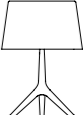
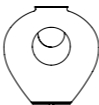





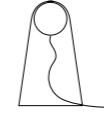



Clicca sui disegni per approfondire i prodotti della stessa famiglia
Click on the drawings to open the products of the same family




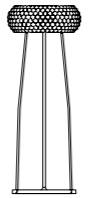

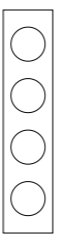



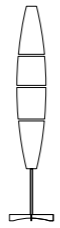


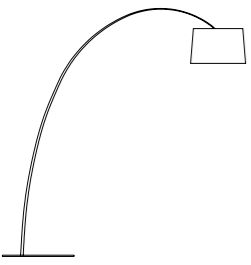
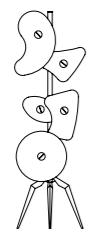
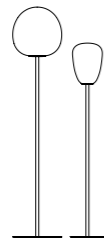


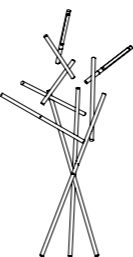




Clicca sul QR code per scoprire altre foto e dettagli
Click on the QR code to discover more pictures and details

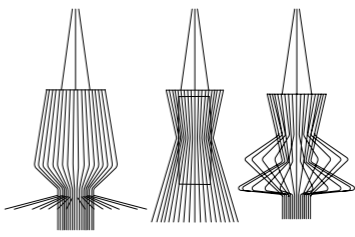
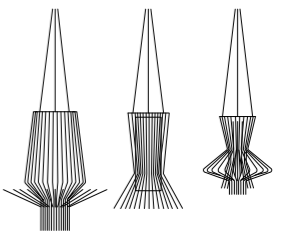
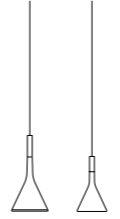
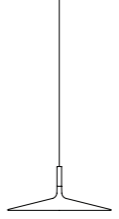
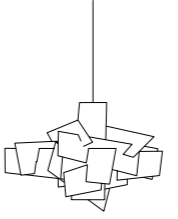
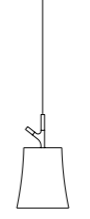
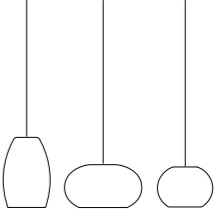
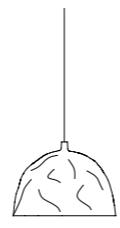
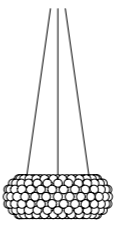
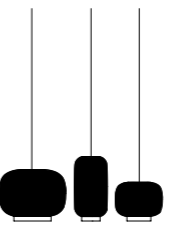
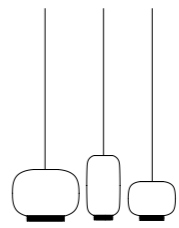
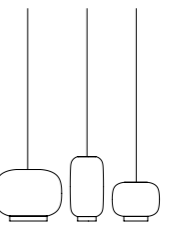
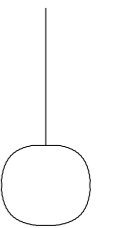

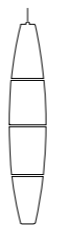
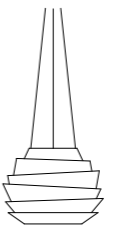
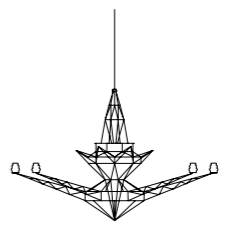
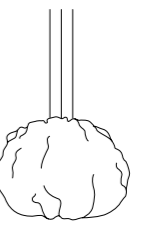
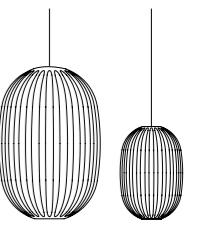
Table →

					
	Anisha	Binic	Birdie	Birdie Easy	Birdie Zero
016	018	020	022	024	026
					
Bridge	Buds		Caboche Plus		
028	030		036		
					
Chapeaux	Filo	Fleur	Gem	Gregg	
038	044		046	050	052
					
Kurage	Light Bulb	Lumiere	Lumiere Nuances	Lumiere 30 th	Lumiere XX
056	058	060	062	068	072
					
Madre	Magneto	Nile	Plass	Poly Gregg	
074	076	078	082	084	
					
Rituals		Satellight	Soffio		
086	092		094		

Floor →

					
Filo	Birdie	Birdie Easy	Caboche Plus	Chiaroscuro	Dolmen
110	098	100	102	104	108
					
Mite	Gem	Gregg	Havana	Lumiere XXL	Magneto
122 - 124	112	114	116	118	120
					
Twiggy / Twiggy Wood / Twiggy Elle / Twice as Twiggy	Orbital	Rituals	Tobia	Tress	Tuareg
140 - 142 - 144 - 146	126	130	132	136	138
					
Twiggly lettura	Uptown				
148	150				

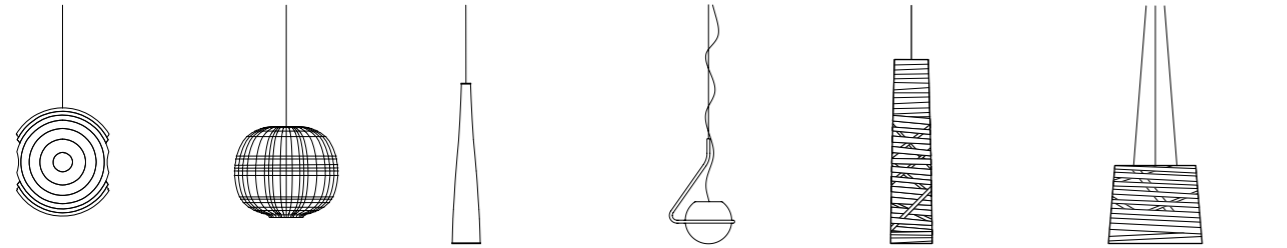
Suspension →

					
Allegro		Allegretto			
152	154	156			
					
Aplomb + mini	Aplomb Large	Big Bang / L / XL	Birdie	Buds	
160	168	170	174	176	
					
Bump	Caboche Plus	Chouchin	Chouchin Reverse	Chouchin Bianco	Gem
180	184	188	192	194	198
					
Gregg	Havana	Le Soleil	Lightweight	Nuée	Plass
200	204	206	208	210	214



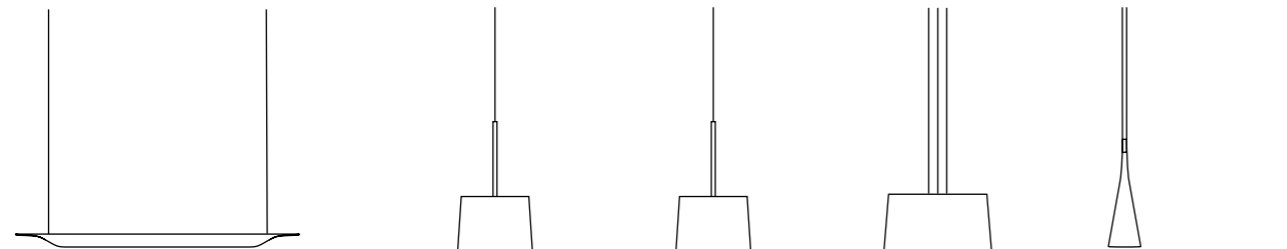
Plena Rituals Satellight Spokes Sun-Light of Love

216 220 222 224 230



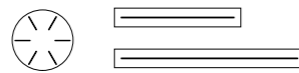
Supernova Tartan Tite Tonda Tress Tress grande

234 238 240 242 246 248



Troag LED Twigg Twigg Wood Twice as Twigg Uto

250 252 254 256 258



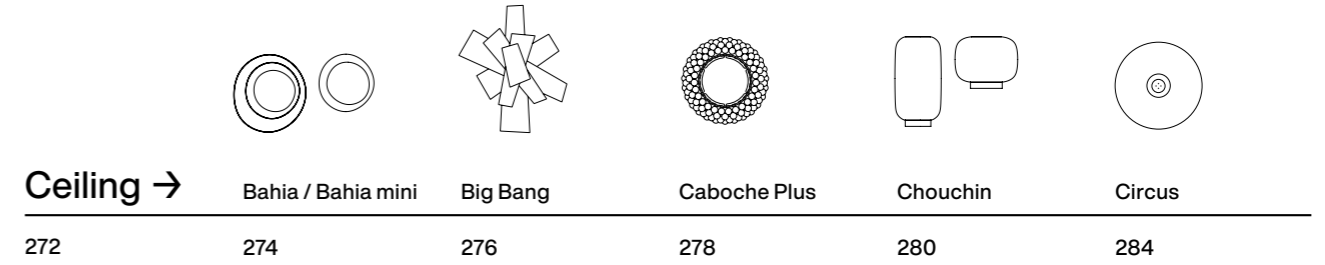
Rosoni multipli
Multiple canopies

Kit decentramento
Decentralization kit

Accessories →

260 262 270

Ceiling →



Bahia / Bahia mini Big Bang Caboche Plus Chouchin Circus

272 274 276 278 280 284



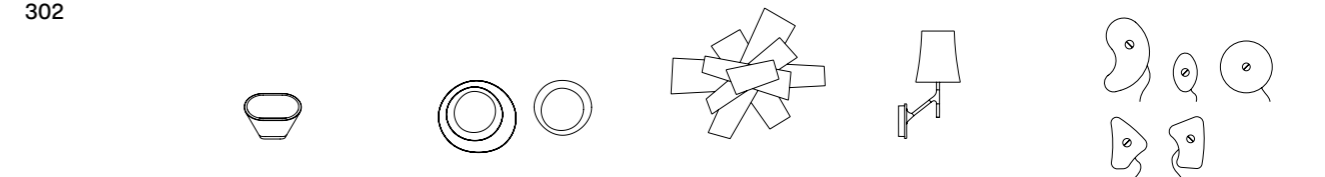
Folio Gem Gregg Lumiere XX Rituals Tartan

286 288 290 294 296 300



302

Wall →



Aplomb Bahia / Bahia mini Big Bang Birdie Bit

304 306 308 310 312 314



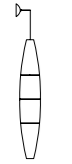
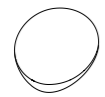


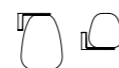

Caboche Plus Chouchin Semi Circus Double Fields Filo

316 318 320 322 324 326







Folio Gem Semi Gioia Gregg Gregg Mirror Gregg Semi

328 330 332 334 336 338






					
Havana	Lake	Le Soleil	Lumiere XX	Rituals	Rituals semi

340	342	344	346	348	350
-----	-----	-----	-----	-----	-----


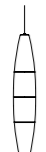

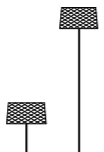
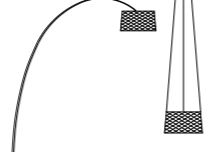

			
Satellight	Tobia	Tress	Tutù

352	354	356	358
-----	-----	-----	-----

Outdoor →

				
Aplomb	Cri Cri	Gregg	Gregg	Gregg

360	362	364	368	370	374
-----	-----	-----	-----	-----	-----

					
Havana	Havana	Solar	Twiggy Grid	Twiggy Grid	Uto

376	378	380	382	384 - 388	390
-----	-----	-----	-----	-----------	-----

Color samples

394

Light sources

410

Communication tools

412

Certifications

414



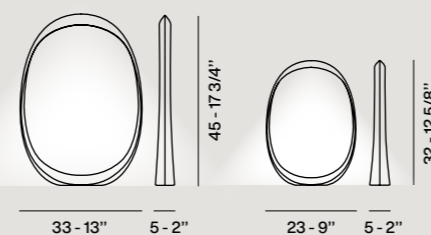
Index — Table lamps

018	Anisha	058	Light Bulb
020	Binic	060	Lumiere
022	Birdie	062	Lumiere Nuances
024	Birdie Easy	068	Lumiere 30 th
026	Birdie Zero	072	Lumiere XX
028	Bridge	074	Madre
030	Buds	076	Magneto
036	Caboche Plus	078	Nile
038	Chapeaux	082	Plass
044	Filo	084	Poly Gregg
046	Fleur	086	Rituals
050	Gem	092	Satellight
052	Gregg	094	Soffio
056	Kurage		



Con la sua cornice avvolgente definisce lo spazio vuoto e lo riempie di luce. La fonte luminosa nascosta permette di valorizzare il suo equilibrio tra vuoto e pieno. Le due dimensioni in cui è proposta e il colore bianco le permettono di adattarsi a molteplici ambienti e funzioni d'uso.

With its enveloping frame it indicates an empty space and fills it with light. The hidden source makes it possible to enhance the balance between emptiness and fullness. The two sizes and white colour allow the lamp to adapt to all kinds of spaces and uses.



ABS stampato a iniezione.
Injection moulded ABS.

Colori — Colors
Bianco. *White.*



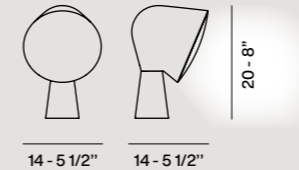
Discover more





Un piccolo faro in Bretagna è la fonte d'ispirazione della lampada la cui forma giocosa e colorata suscita immediata simpatia. Il volume superiore tondeggiante appoggia su una base conica proiettando una luce intensa e omogenea. I colori disponibili permettono un'ampia adattabilità.

A small lighthouse in Brittany is the source of inspiration for this lamp with an immediately engaging, playful and colourful form. The rounded upper volume rests on a conical base, projecting intense, homogeneous light. The range of available colours makes this model very adaptable.



ABS masterizzato e policarbonato.
Batch-dyed ABS and polycarbonate.

Colori — Colors
Bianco, rosa, verde acqua, blu, giallo, antracite.
White, pink, turquoise green, blue, yellow, anthracite.

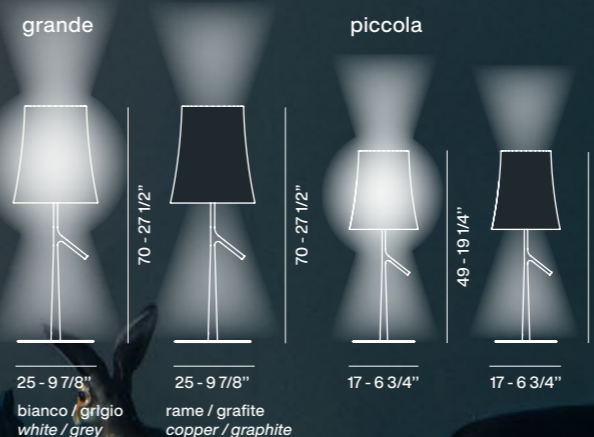


Discover more



Uno stelo sottile come il fusto di un albero, un paralume dalla classica forma e un sistema di accensione disegnato come un ramo. Tre elementi che danno vita a una lampada dal segno leggero e familiare. Disponibile in due dimensioni si inserisce con naturalezza nell'habitat domestico.

A slender stem, like the trunk of a tree. A shade with a classic form and a control system designed like a branch. Three parts that combine to create a lamp with a light, familiar look. Available in two sizes, for a natural fit in any domestic habitat.



Policarbonato o ABS, acciaio e metallo verniciato.
Polycarbonate or ABS, varnished steel and metal.

Colori — Colors
Bianco, grigio, grafite, rame.
White, grey, graphite, copper.



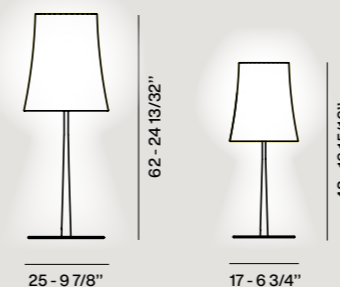
Collection

Discover more



Il design versatile di Birdie guadagna in essenzialità e sceglie di esprimere il suo stile attraverso il colore. Base e asta in metallo in 6 colori diversi, accostate al diffusore bianco traslucido, la rendono adatta agli ambienti più vari. Minimale e leggera, è disponibile in due misure.

The versatile design of Birdie takes on essential appeal and chooses to express its style through colour. Metal base and rod in 6 different colours, combined with the translucent white diffuser, make it suitable for the widest range of settings. Minimal and light, it is available in two sizes.

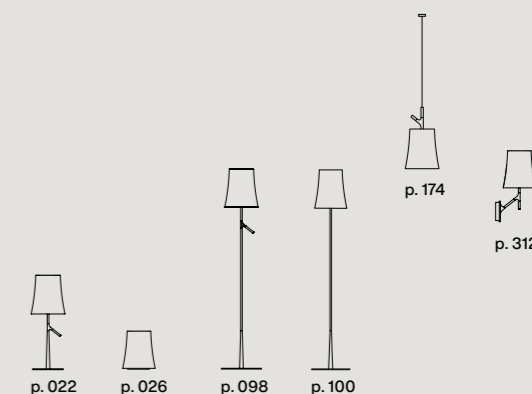


Policarbonato e metallo verniciato.
Polycarbonate and coated metal.

Colori — Colors
Diffusore: bianco.
Montatura: bianco, nero, rosso mattone, azzurro, giallo sabbia, verde salvia.
Diffuser: white.
Frame: white, black, brick red, light blue, sand yellow, sage green.



Collection

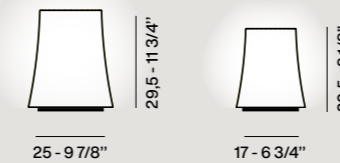


Discover more



L'essenza fatta lampada. Il diffusore bianco traslucido è la lampada stessa che nasconde la tecnologia liberando la sola funzione. L'estetica incisiva ma non invadente si armonizza con gli stili abitativi più vari. Una lampada robusta e accessibile, da posizionare su comodini anche di grandi strutture ricettive.

The essence becomes a lamp. The translucent white diffuser is the lamp itself which conceals the technology, revealing solely its function. The distinctive but never invasive look blends perfectly with a wide range of lifestyles. A sturdy, affordable lamp, to place on bedside tables, also in large hospitality facilities.



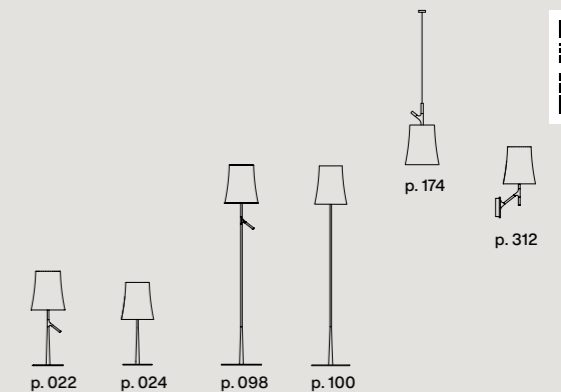
Policarbonato e metallo verniciato.
Polycarbonate and coated metal.

Colori — Colors
Bianco. *White.*



Collection

Discover more



Bridge, design Francesco Meda, 2022

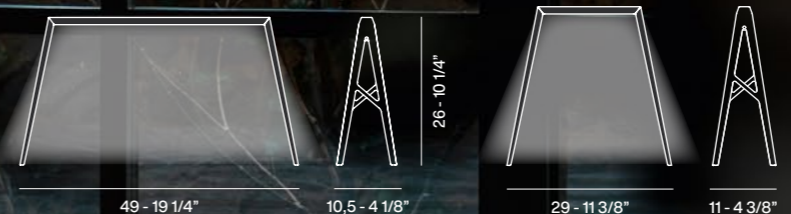
Una presenza discreta ma importante, come una scultura. Prende forma da un'unica lastra di metallo tagliata al laser e piegata senza giunzioni a formare un ponte luminoso che proietta una luce funzionale sul piano. Si accende e si spegne con un semplice passaggio della mano. Un oggetto contemporaneo, ma senza tempo.

Bridge is a discreet but vivid presence, like a sculpture. It takes form from a single sheet of steel, cut by lasers, and folded without joints to make a luminous bridge that projects direct, functional light on the surface. The lamp turns on and off with a wave of the hand, requiring no direct contact.



Bridge 1

Bridge 2



Ottone o acciaio.
Brass or steel.

Colori — Colors
Ottone, rosso scuro.
Brass, dark red.



Discover more



Buds

Table

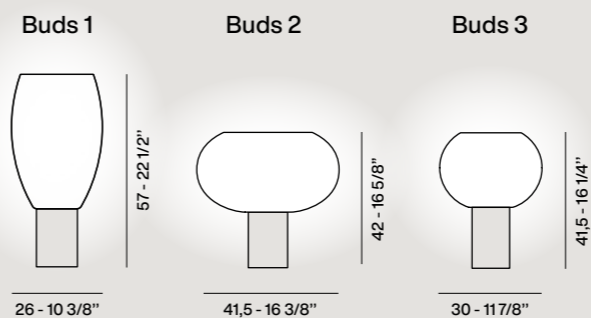






Protagonista del progetto è il diffusore in vetro soffiato con lavorazione artigianale a cinque strati, accostato ad una base trasparente che sottolinea l'eleganza del suo design. Lo strato interno di vetro in tonalità "pagliesco" (giallino pallido) rende la luce più calda e il colore più intenso. La versione "bianco caldo" appare bianco da spenta e colore avorio a lampada accesa.

The most striking feature is the diffuser in handmade blown glass with five layers, combined with a transparent base which enhances the elegance of its design. The internal glass layer is a pale, straw-yellow colour to make the light warmer and the colour more intense. The "warm white" version appears ivory when the lamp is on and white when off.

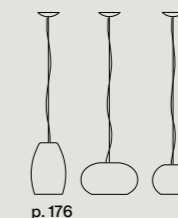


Vetro soffiato e PMMA.
Blown glass and PMMA.

Colori — Colors
Buds 1 bianco caldo.
Buds 2 grigio, bianco caldo.
Buds 3 verde bambù, bianco caldo.
Buds 1 warm white.
Buds 2 grey, warm white.
Buds 3 bamboo green, warm white.



Collection

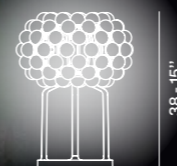


Discover more



Più trasparenza, più leggerezza formale e una luce ancora più brillante. Grazie ai nuovi archetti e al nuovo sistema di aggancio a baionetta le sfere sembrano galleggiare nel vuoto, con un effetto di trasparenza totale molto suggestivo. Quando è accesa, la luce si diffonde all'interno delle sfere che, simili a cristalli, illuminano l'ambiente a 360°. Proposta in versione trasparente o in un raffinato colore grigio.

More transparency, lighter shapes, and an even brighter light. Thanks to the new arches and to the new "twist lock" attachment system, the spheres appear to float in space, creating a truly beguiling total transparency effect. When it is switched on, the light is diffused inside the spheres which, like a myriad crystals, light the surroundings through 360°. Available in transparent or in a refined grey colour version.



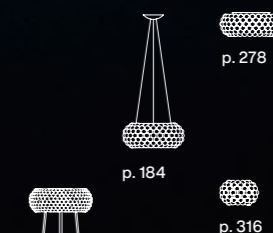
31 - 12 1/4"

PMMA, policarbonato, alluminio e metallo verniciato.
PMMA, polycarbonate, aluminium and varnished metal.

Colori — Colors
Trasparente, grigio.
Transparent, grey.



Collection



p. 102

Discover more





Chapeaux



Foscarini — Collezioni

Table



041



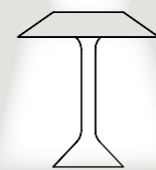
Chapeaux, design Rodolfo Dordoni, 2023

Table

Tre personalità, tre tipi di luce, tre modi di arredare. Un progetto raffinato ed elegante i cui elementi compositivi sono stati ridotti al minimo. Un sostegno in vetro borosilicato trasparente che quasi scompare alla vista, un cuore luminoso e tre diversi cappelli in appoggio libero – in metallo, vetro, e porcellana Bone China.

Three personalities, three types of light, three approaches to décor. A refined, elegant design whose components have been reduced to a minimum. A borosilicate glass support that nearly vanishes from view, a luminous core and three different freely placed “hats” – in metal, glass and Bone China.

Metallo / Metal



44 - 17"

47 - 18"

Vetro / Glass



29 - 11"

47 - 18"

Porcellana / Porcelain



35 - 13"

47 - 18"

Vetro borosilicato, vetro soffiato o acciaio verniciato o porcellana, alluminio e policarbonato.
Borosilicate glass, blown glass or varnished steel or porcelain, aluminum, and polycarbonate.

Colori — Colors

Metallo: ocra, rosso scuro, grigio.
Vetro: bianco caldo, grigio.
Porcellana: bianco.
Metal: ochre, dark red, grey.
Glass: warm white, grey.
Porcelain: white.



Discover more



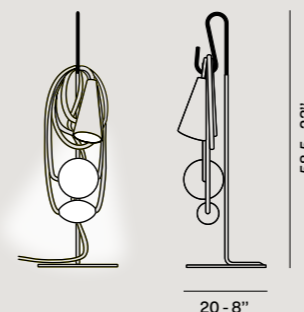


Filo, design Andrea Anastasio, 2017

Table

Arte e luce. Un oggetto che nasce dallo scomporre le singole parti che compongono una lampada - sorgente luminosa, decorazione e cavo elettrico - per ricomporle in un'operazione artistica, frutto del pensiero del suo autore Andrea Anastasio. Un abaco di colori le dona molteplici identità.

Art and light. This project stems from breaking apart the individual parts used to make up a lamp - light source, decoration and electrical cable - to put them back together in an artistic masterpiece, resulting from the concept of its designer Andrea Anastasio. Different colours offer multiple identities.

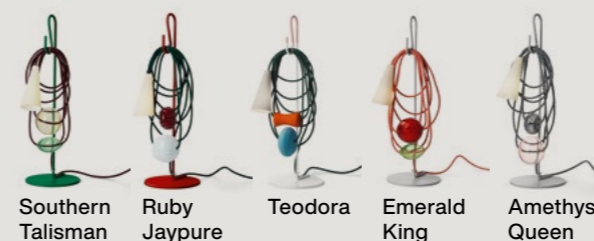


Porcellana, cavo tessile, vetro soffiato e metallo verniciato.
Porcelain, textile cable, blown glass and varnished metal.

Versioni disponibili
— Available versions:

Collection

Discover more



Fleur

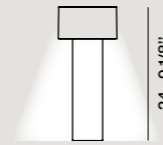
Table





Lampada portatile a batteria pensata anche come decoro per la tavola che può contenere acqua e un fiore. Elegante e attenta la proporzione visiva tra i due volumi che la compongono. La fonte luminosa miniaturizzata nel corpo superiore illumina e sottolinea il profilo dello stelo in vetro.

A portable battery lamp also conceived as a decorative piece for the table, which can contain water and a flower. Its elegance is the result of the visual proportions of the two volumes that form the composition. The miniaturized light source in the upper part illuminates and underscores the profile of the glass stem.



11 - 4 1/8"

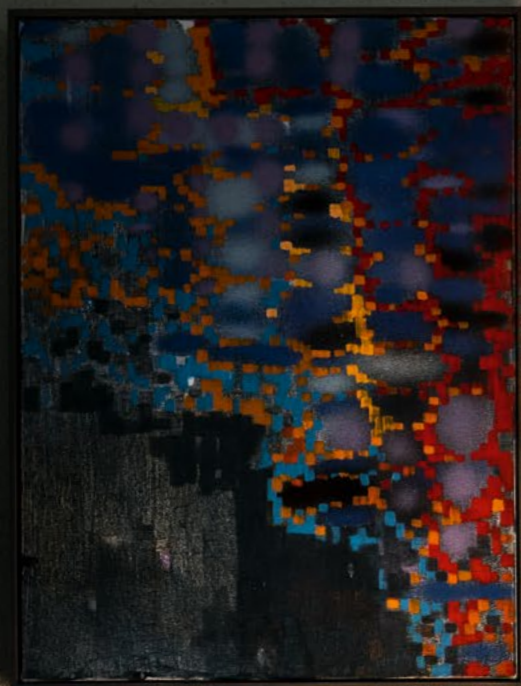
Vetro borosilicato, ABS,
PMMA.
*Borosilicate glass, ABS,
PMMA.*

Colori — Colors
Burgundy, bianco, verde
salvia.
Burgundy, white, sage green.



Discover more



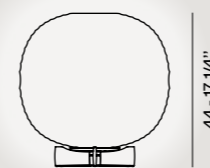


Gem, design Ludovica + Roberto Palomba, 2017

Table

Una vibrazione fluida sul vetro soffiato a bocca. Una lampada da tavolo che seduce, dichiarando a prima vista la preziosità del materiale e la sapienza della lavorazione artigianale. Anche da spenta dona eleganza a ogni ambiente.

A fluid vibration on glass. A table lamp which is a seductive object that declares at first glance the superior value of the material and the fine craftsmanship of its manufacturing process. It lends any setting elegance even when it is switched off.



43 - 17"

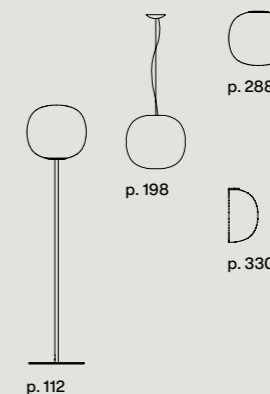
44 - 17 1/4"

Vetro soffiato in rilievo e acidato, metallo satinato con doratura.
Blown acid-etched glass with reliefs, gold-plating satin metal.

Colori — Colors
Bianco. *White.*



Collection



Discover more

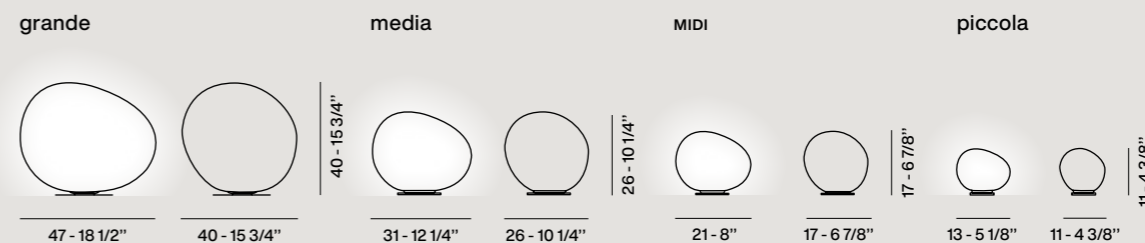






Come ciottoli levigati di fiume, cambia immagine a seconda del punto di vista da cui si osserva. La luce calda e uniforme irradiata dal diffusore di vetro satinato bianco soffiato a bocca dona un piacevole valore arredativo. Diverse dimensioni per ampia versatilità di utilizzo.

Like stones polished by a river, it changes its look depending on the vantage point of the observer. The warm, uniform radiance of the frosted white handmade blown glass diffuser provides high decorative impact. In different sizes for flexible use.

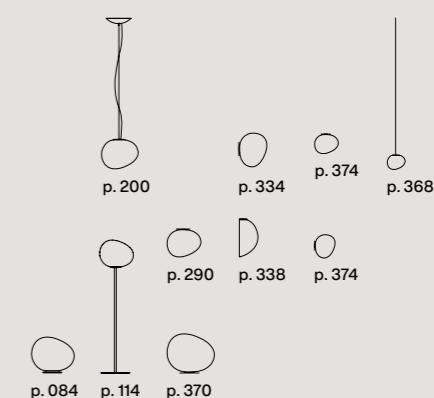


Vetro soffiato acidato, metallo verniciato o policarbonato.
Blown acid-etched glass, coated metal or polycarbonate.

Colori — Colors
Bianco. White.



Collection



Discover more



Con il suo spirito poetico e artigianale, è realizzata grazie alla lavorazione tridimensionale della carta washi giapponese che filtra la luce creando un'atmosfera rilassata e calda. Le sottili gambe in legno di frassino, il portalampade in ceramica e il cavo rivestito completano il progetto.

With its poetic spirit and fine workmanship, the lamp relies on 3D shaping of Japanese washi paper to filter light, creating a relaxing, warm atmosphere. The slender legs in ash wood, ceramic bulb housing and sheathed cable complete the design.



51 - 20 1/4"

34 - 13 1/4"

Carta washi e legno di frassino.
Washi paper and ashwood.

Colori — Colors
Bianco. White.



Discover more



Parte di una collezione d'autore che nasce dalla riflessione sulla lampadina come archetipo. White Light, con la tipica forma a bulbo, è la matrice, l'icona di base. Black Light lavora sull'inversione: il porta-lampada emana luce, mentre la lampadina rimane "buia". Una tentazione accessibile per chi è affascinato dall'approccio concettuale e dalla riflessione critica dell'architetto James Wines. Con scatola personalizzata.

Part of a signature collection based on thinking about the light bulb as an archetype. White Light, with its typical form, is the matrix, the basic icon. Black Light works on the concept of inversion: the bulb housing emits light, while the bulb itself remains "dark". An affordable temptation for those who are fascinated by the conceptual approach of critical reflection of the architect James Wines. Comes in a personalized box.

White Light



14 - 5 1/2"

15 - 6"

Black Light



14 - 5 1/2"

15 - 6"

Vetro soffiato e alluminio.
Blown glass and aluminium.

Colori — Colors
Bianco, bianco/nero.
White, white/black.



Discover more



Rilettura della classica abat-jour, è contraddistinta dal prezioso diffusore in vetro soffiato unito a un inconfondibile treppiede in alluminio. La raffinata eleganza insieme alla sua luce diffusa, calda e intensa, la rendono perfetta per essere inserita in svariate ambientazioni.

A reinterpretation of the classic table lamp with shade, the lamp stands out for its precious blown glass diffuser combined with a striking aluminium tripod. Refined elegance and warm, intense light make it a perfect choice for all kinds of settings.

grande



27 - 10 1/2"

piccola

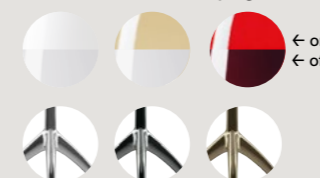


20 - 7 7/8"

Vetro soffiato e alluminio spazzolato lucido o verniciato. *Blown glass and polished or painted brushed aluminium.*

Colori — Colors

Vetro: bianco, bianco caldo, ciliegia. Montatura: alluminio, cromo nero, champagne. *Glass: white, warm white, cherry. Frame: aluminium, black chrome, champagne.*



Collection



Discover more



 p. 062-068

 p. 072

 p. 118

 p. 294
 p. 346





Lumiere Nuances

Table



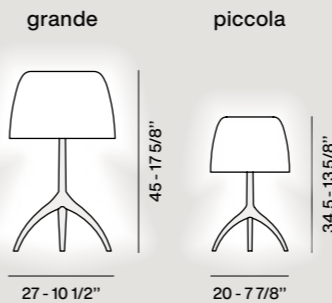
Foscarini — Collezioni

065



Una lampada iconica elegante e raffinata, proposta con una palette cromatica in cui le parti metalliche sono coordinate al colore del diffusore in vetro soffiato, che si illumina di luce e calore a lampada accesa. Una collezione di tinte estremamente attuali, esaltate dalla finitura opaca della base.

An elegant and sophisticated iconic lamp, available in a range of colours, in which the metal parts match the colour of the blown glass diffuser, which glows with light and warmth when the lamp is switched on. An extremely trendy collection of hues, emphasised by the matt finish of the base.

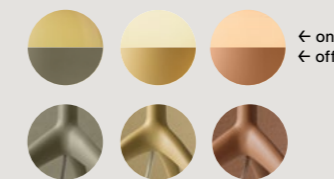


Vetro incamiciato soffiato a bocca e alluminio spazzolato verniciato.
Hand-blown cased glass and painted brushed aluminium.

Colori — Colors
Vetro e montatura: creta, sahara, cipria.
Glass and frame: clay, sahara, powder pink.

Collection

Discover more

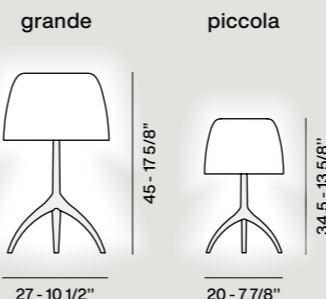




Chimica
DUPRE-LAFON
JEAN-MICHEL FRANK
Il...

Nata nel 1990, in questi 30 anni Lumiere si è vestita di colori e finiture sempre diverse. Nella sua piena maturità, può osare anche un abito in cui due storiche lavorazioni artigianali del vetro soffiato a bocca arricchiscono il diffusore bianco lucido. Per la prima volta il decoro sulla superficie del vetro diventa tridimensionale: la classe resta immutata, e ne guadagna il carattere.

Created in 1990, in this span of 30 years Lumiere has taken on many different colours and finishes. Today, in its full maturity, it can dare to take on a new look, thanks to two historic glassblowing techniques that enhance the glossy white shade. The surface decoration of the glass becomes three-dimensional for the first time: the class remains the same, but takes on new character.

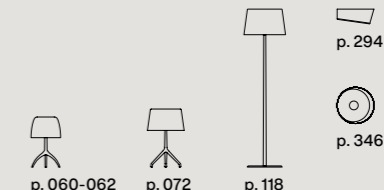
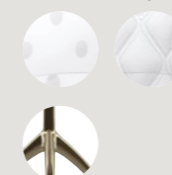


Vetro incamiciato soffiato a bocca e alluminio spazzolato verniciato.
Hand-blown cased glass and painted brushed aluminium.

Colori — Colors
Vetro: Bulles, Pastilles.
Montatura: champagne.
Glass: Bulles, Pastilles.
Frame: champagne.

Collection

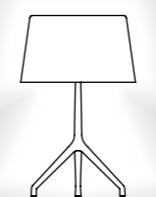
Discover more



Il modello originale di Lumiere ha ispirato le versioni XXL ed XXS, dalle proporzioni più ampie e dal segno più deciso. Il bianco e il grigio freddo sono le raffinate proposte di colore per il paralume in vetro soffiato a bocca, in abbinamento alle finiture alluminio o cromo nero per la montatura.

The original Lumiere model has suggested XXL and XXS versions, with varied proportions for a decisive presence. White and cool grey are the refined hues for the handcrafted blown glass shade, matched with an aluminium or black chrome finish for the structure.

Lumiere XXL



37 - 14 5/8"

58 - 23"

Lumiere XXS



26 - 10 1/4"

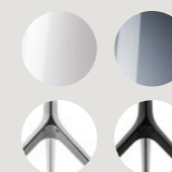
40 - 15 5/8"

Vetro soffiato e alluminio spazzolato verniciato.
Blown glass and painted brushed aluminium.

Colori — Colors
Vetro: bianco, grigio freddo.
Montatura: alluminio, cromo nero.
*Glass: white, cool grey.
Frame: aluminium, black chrome.*

Collection

Discover more



p. 060-062-068



p. 118



p. 294



p. 346

Madre

Madre, design Andrea Anastasio, 2019

Table

Con la sua forma allude ai fianchi ampi delle dee della fertilità. Il suo corpo luminoso accoglie un vaso di vetro borosilicato satinato dove è possibile inserire dei rami per creare un insieme elegante. Il foro che interrompe il vaso al centro crea una visione magica e una luce unica.

The form alludes to the wide hips of fertility goddesses. The ample luminous body contains a vase in frosted borosilicate glass in which to insert branches to create elegant compositions. The hole at the centre generates a magical vision and unique light.



35 - 13 3/4"

36 - 14 3/4"

Vetro soffiato, vetro borosilicato, alluminio verniciato e policarbonato.
Blown glass, borosilicate glass, varnished aluminum and polycarbonate.

Colori — Colors
Bianco. *White.*



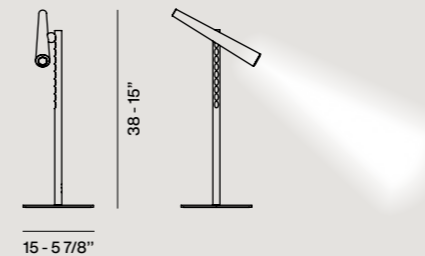
Discover more





Fulcro del progetto è una calamita sferica che unisce due semplici elementi, un'asta di sostegno e un compatto corpo illuminante con un'estrema versatilità di regolazione e spostamento lungo l'asta. Flessibilità d'uso unita a un rigore funzionale assoluto.

The fulcrum of the project is a spherical magnet that joins two simple parts, a support rod and a compact light source, with extreme versatility of regulation and movement along the stem. Flexible use combined with absolute functional rigor.



Acciaio verniciato, ABS e supermagnete in terre rare.
Coated steel, ABS and super magnet made of "rare earth".

Colori — Colors
Bianco, nero.
White, black.



Collection

Discover more



p. 120

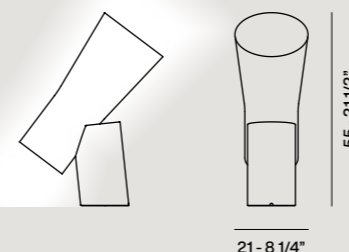


ARABIAN LEOPARD
Treasures of the
ABSOLUT

GILBERT & GEORGE
L'ŒUVRE EN IMAGES / 2
GILBERT & GEORGE
L'ŒUVRE EN IMAGES / 1

Una lampada d'arredo di grande carattere in cui la base in marmo incontra il calore artigianale del diffusore in vetro soffiato. La composizione dinamica dei volumi sembra sfidare la legge di gravità e conferisce una sofisticata eleganza. Bellissima già da spenta, si accende di meraviglia quando la luce filtra attraverso il prezioso vetro soffiato a bocca, dirigendosi verso il basso sul piano e verso l'alto attraverso i due lati aperti del diffusore.

A decorative lamp of remarkable character that blends contrasting elements: the consistency of the marble base and the handmade warmth of the blown glass diffuser. The dynamic arrangement of these two volumes seems to defy the law of gravity and brings sophisticated elegance to any space. Already beautiful when off, it takes on even more allure when the light filters through the precious blown glass, shining down to the surface below and upward through the two open sides of the diffuser.



Vetro incamiciato soffiato a bocca e marmo di Carrara o Marquina.
Blown glass and Carrara or Marquina marble.

Colori — Colors
Diffusore: bianco. Base: marmo bianco di Carrara, marmo nero Marquina.
Diffuser: white. Base: white Carrara marble, black Marquina marble.



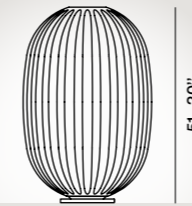
Discover more





Un progetto che interpreta l'immagine di una perla di vetro utilizzando il policarbonato trasparente stampato in rotazionale. Grazie alla tecnologia le finiture sono caratterizzate dalle tipiche irregolarità che ricordano il vetro artigianale e fanno vibrare la luce.

A project that conveys the image of a glass bead by using rotomoulded transparent polycarbonate. Thanks to this technology the finish has typical irregularities, like those of handcrafted glass, making the light more vibrant.

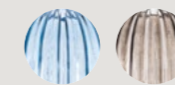


33,5 - 13 1/8"

51 - 20"

Policarbonato stampato in rotazionale e acciaio verniciato.
Rotational moulded polycarbonate and coated steel.

Colori — Colors
Azzurro, grigio.
Light blue, grey.



Collection



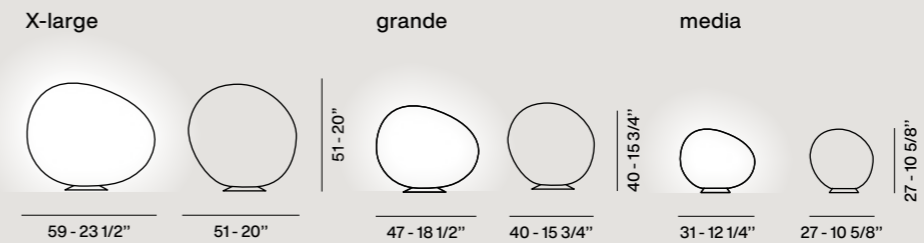
p. 214

Discover more



Il design organico e familiare di Gregg riprodotto in una versione in polietilene, materiale leggero e resistente agli urti. Disponibile in tre diverse misure per integrarsi in ogni situazione e creare libere composizioni. Luce diffusa e piacevole.

The organic, familiar design of Gregg, reproduced in a polyethylene version, a material that is light and resistant to impact. Available in three different sizes to fit into any situation, creating free compositions. For pleasant, diffused light.

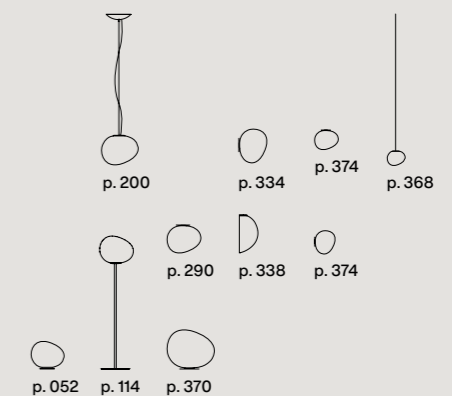


Polietilene stampato in rotazionale e metallo verniciato.
Rotational moulded polyethylene and coated metal.

Colori — Colors
Bianco. *White.*



Collection



Discover more



Rituals

Table



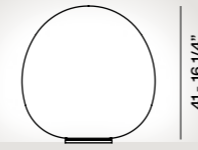




Si ispirano alle lampade di carta della tradizione orientale ma sono realizzate in vetro soffiato a bocca arricchito da sottili incisioni, al contempo decoro e filtro per la luce, che si diffonde calda e soffice nell'ambiente. Una famiglia di lampade da tavolo che parla il linguaggio della bellezza e della poesia, in equilibrio tra oriente e occidente.

A collection of lamps that draw their inspiration from traditional Oriental paper lanterns but are made with hand-blown glass marked by thin engravings that are concurrently decorative as well as filtering light, which is diffused into the surroundings, warm and soft. Lamps that speak the language of beauty and poetry, striking a balance between East and West.

Rituals XL



40 - 15 3/4"

41 - 16 1/4"

Rituals 1



24 - 9 5/8"

40 - 15 7/8"

Rituals 2



34 - 13 3/8"

25 - 10"

Rituals 3



20 - 7 5/8"

Vetro soffiato satinato inciso e metallo verniciato.
Blown engraved satin glass and coated metal.

Colori — Colors
Bianco. White.



Collection



p. 220



p. 296



p. 130



p. 350



p. 298

Discover more



Un globo luminoso e sospeso è il cuore di Satellight. Il diffusore in vetro soffiato a bocca di colore bianco latte è inserito in un corpo di vetro cristallo trasparente che, come per magia, sostiene la sfera luminosa. La luce che ne deriva è morbida e calda.

A luminous, suspended globe is the heart of Satellight. The blown glass diffuser in a milky white shade is inserted in a volume of transparent crystal, which supports the luminous sphere as if by magic. For soft, warm lighting.



24 - 9 7/16"

39 - 15 1/4"

Vetro soffiato e alluminio.
Blown glass and aluminium.

Colori — *Colors*
Bianco e trasparente.
White and transparent.



Collection



p. 222

p. 352

Discover more





Soffio, design Ludovica + Roberto Palomba, 2018

Table

Una lampada da tavolo elegante dall'estetica sobria e dalle dimensioni importanti, emana una luce calda e intensa definendo l'ambiente in modo raffinato. La sfumatura del diffusore è il risultato di maestria artigianale; ogni pezzo è unico. Il vetro bianco produce un illuminamento basso di area. Il vetro trasparente si comporta da piedistallo per la parte superiore.

A lamp with an understated look, Soffio spreads warm, intense light, setting a refined tone for any space. The shading of the diffuser is a feat of craftsmanship; each piece is one of a kind. The white glass produces soft area lighting, while the transparent glass functions as a pedestal for the upper part.



50 - 19 7/8"

30 - 11 5/8"

Vetro soffiato e alluminio.
Blown glass and aluminium.

Colori — Colors
Trasparente e bianco sfumato.
Transparent and fading white.



Discover more

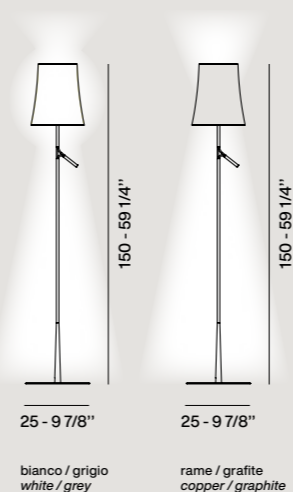


Index — Floor lamps

098	Birdie	126	Orbital
100	Birdie Easy	130	Rituals
102	Caboche Plus	132	Tobia
104	Chiaroscuro	136	Tress
108	Dolmen	138	Tuareg
110	Filo	140	Twiggy
112	Gem	142	Twiggy Wood
114	Gregg	144	Twiggy Elle
116	Havana	146	Twice as Twiggy
118	Lumiere XXL	148	Twiggy lettura
120	Magneto	150	Uptown
122	Mite		
124	Mite Anniversario		

Birdie è una reinterpretazione in chiave contemporanea della classica lampada con paralume. Un modello che coniuga un segno leggero e familiare e un carattere deciso. Sempre monocromatica, Birdie terra assume diverse personalità a seconda del colore.

Birdie is a reinterpretation of the classic lampshade-lamp, with a contemporary twist. This model combines a light and familiar design with a strong character. Always monochromatic, the Birdie floor lamp takes on different personalities depending on its colour.



bianco / grigio
white / grey

rame / grafite
copper / graphite

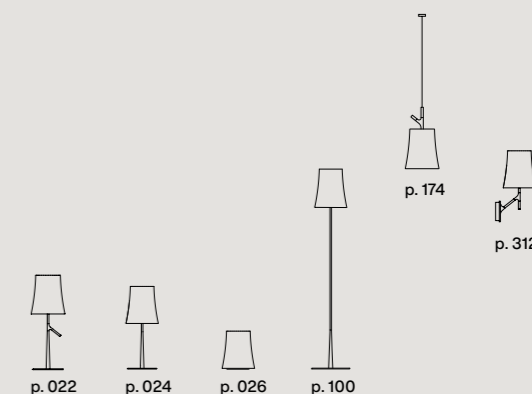
Policarbonato o ABS, acciaio e metallo verniciato.
Polycarbonate or ABS, varnished steel and metal.

Colori — Colors
Bianco, grigio, rame, grafite.
White, grey, copper, graphite.



Collection

Discover more



Il design versatile di Birdie guadagna in essenzialità e sceglie di esprimere il suo stile attraverso il colore. Base e asta in metallo in 6 diversi colori, accostate al diffusore bianco traslucido, la rendono adatta agli ambienti più diversi.

The versatile design of Birdie takes on essential appeal and chooses to express its style through colour. Metal base and rod in 6 different colours, combined with the translucent white diffuser, make it suitable for the widest range of settings.

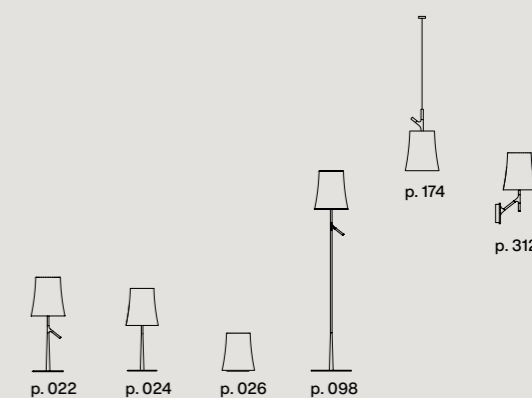


Policarbonato e metallo verniciato.
Polycarbonate and varnished metal.

Colori — Colors
Diffusore: bianco.
Montatura: bianco, nero, rosso mattone, azzurro, giallo sabbia, verde salvia.
Diffuser: white.
Frame: white, black, brick red, light blue, sand yellow, sage green.



Collection

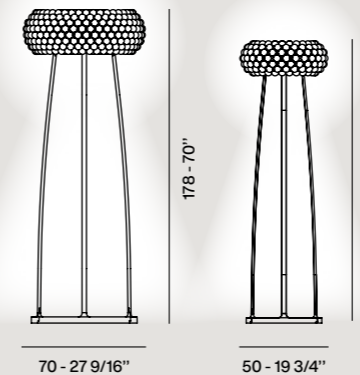


Discover more



Gioiello di design, scintillante e preziosa come un bracciale, ha una base in metallo con disegno circolare che riprende la forma del diffusore. Riprogettata con nuovi archetti, un nuovo sistema di aggancio e nuove sfere, oltre ad una nuova scheda LED. Quando è accesa, la luce si diffonde dall'interno delle sfere, garantendo un'illuminazione verso l'alto, il basso e diffusa nell'ambiente.

A genuine design gem, sparkling and precious like a bracelet, it has a metal base with a circular design that reflects the shape of the diffuser. Redesigned with new arches, a new "twist-lock" attachment system and new spheres, beside a new LED board. When switched on, light is diffused from inside the spheres, creating an upward and downward lighting effect as well as spreading light around the room.

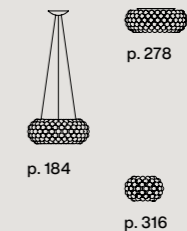


PMMA, policarbonato, alluminio e metallo verniciato.
PMMA, polycarbonate, aluminium and varnished metal.

Colori — Colors
Trasparente, grigio.
Transparent, grey.



Collection



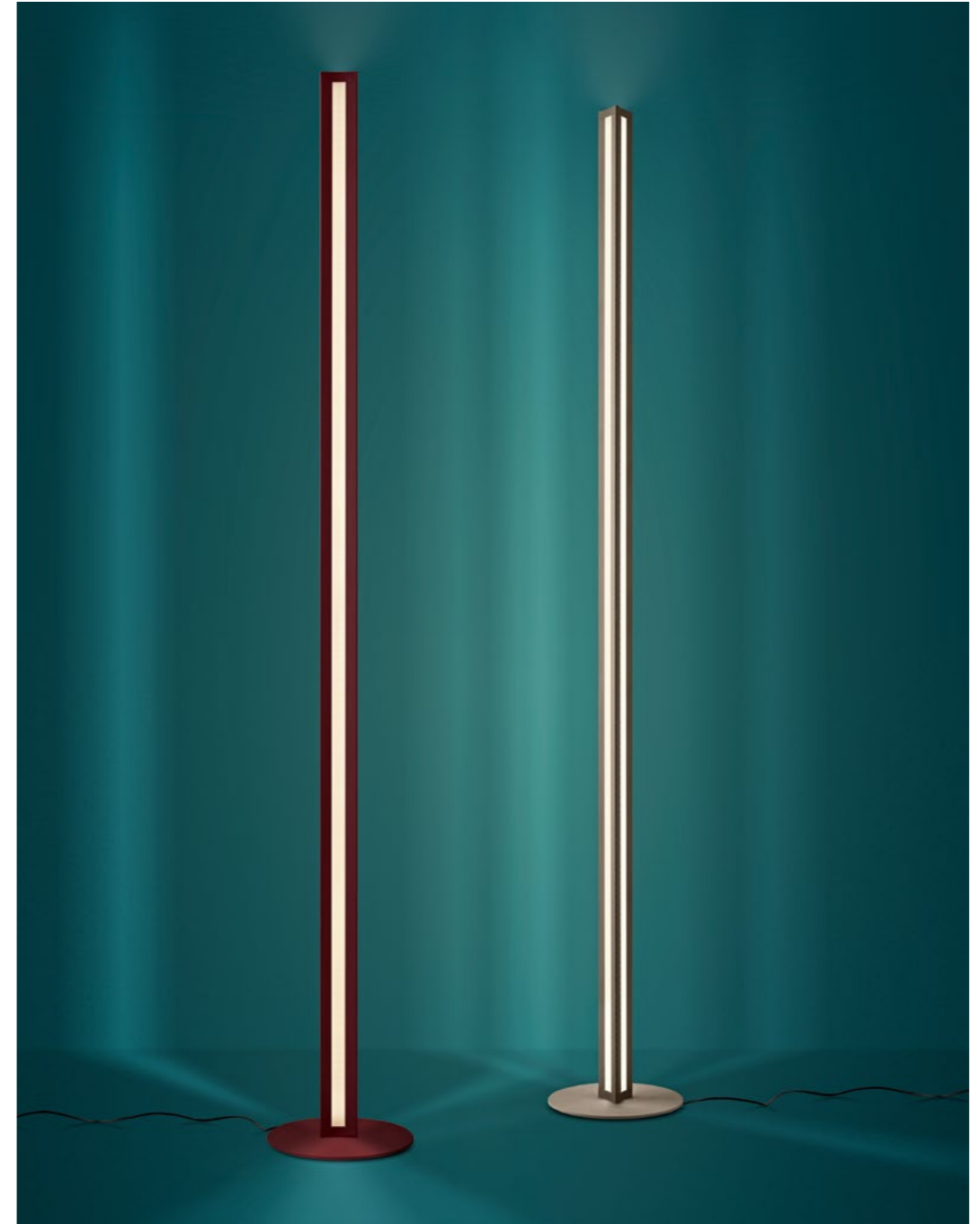
Discover more



Chiaroscuro



Floor





Lampada da terra a luce diffusa e indiretta verso l'alto. Le due schede LED create appositamente sono distribuite sulla lunghezza dello stelo e sulla sommità. Trasformatore allocato nel dimmer originale Foscarini nero a pedale per la funzione di accensione/spegnimento e la regolazione della luminosità.

Floor lamp with diffused and indirect up light. The two purpose-designed LED boards are placed along the length of the rod and on the tip. Transformer allocated to the original black Foscarini pedal dimmer for on/off and brightness adjustment.



Alluminio e metallo verniciato, PMMA.
Liquid-coated aluminium and metal, PMMA.

Colori — Colors
Rosso scuro, titanio.
Dark red, titanium.

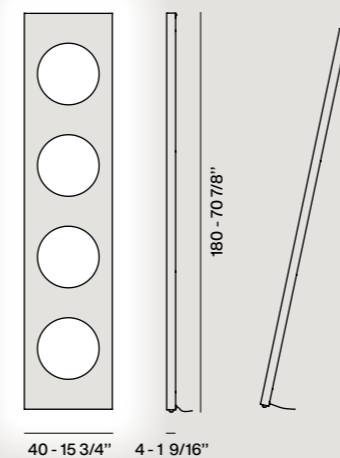


Discover more



Un pezzo dal forte valore simbolico, nato alla metà degli anni '90 e rivisitato con tecnologia LED. Una lampada-scultura che non passa mai inosservata per l'eccezionalità della sua forma, con quattro grandi fori simili agli oblò di una nave e per l'insolita collocazione ad appoggio.

A piece with strong symbolic value, created in the mid-90s and reworked with LED technology. A lamp-sculpture that never goes unnoticed, thanks to its exceptional shape, with four large holes similar to the portholes of a ship, and its unusual positioning against the wall.



Alluminio anodizzato e PMMA.
Anodised aluminium and PMMA.

Colori — Colors
Alluminio.
Aluminium.



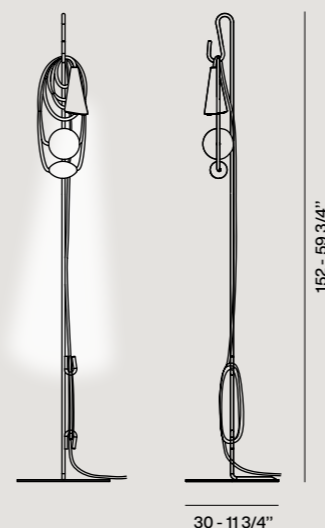
Discover more





Un'operazione artistica, frutto del pensiero di un autore che scompone e poi ricompone la lampada nelle sue singole componenti. Non convenzionale, con una fortissima carica arredativa, la lampada da terra Filo è un abaco di colori in cui anche il cavo elettrico diventa decoro.

This is a work of art, the result of the designer's idea to reduce a lamp to its constituent parts before putting them back together. Unconventional and with great décor appeal, the Filo floor lamp is an abacus of colours in which even the electrical cable becomes a decorative element.



Porcellana, cavo tessile, vetro soffiato e metallo verniciato.
Porcelain, textile cable, blown glass and varnished metal.

Versioni disponibili
— Available versions:
Amethyst Queen, Emerald King, Teodora, Eastern Coral.

Le versioni disponibili sono quelle illustrate a pag. 045.
The available versions are those shown at page 045.

Collection

Discover more



p. 326



p. 044



Un oggetto che seduce, Gem dichiara la preziosità del materiale e la maestria della lavorazione artigianale. Una vibrazione fluida, onde e rilievi che mutano continuamente sul vetro. Anche da spenta dona eleganza a ogni ambiente e crea inattesi effetti luminosi quando è accesa.

Gem is a seductive object that displays the precious quality of its material and its fine craftsmanship. A fluid vibration, waves and patterns that constantly shift on the glass. Even when not in use, it adds elegance to any space. When it is on, it creates unexpected luminous effects.



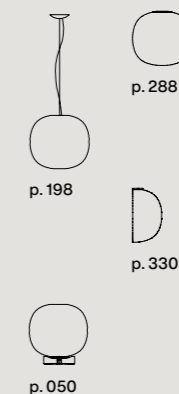
43 - 16 7/8"

Vetro soffiato in rilievo e acidato, metallo verniciato.
Blown acid-etched glass with reliefs, varnished metal.

Colori — Colors
Vetro: bianco. Montatura: bianco, oro, grafite.
Glass: white. Frame: white, gold, graphite.



Collection



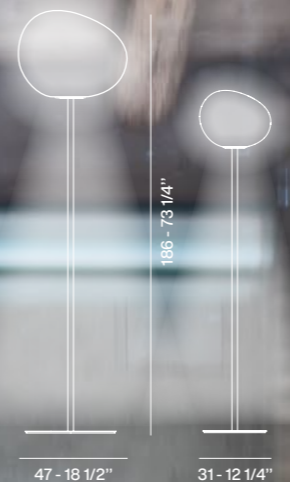
Discover more



Gregg, design Ludovica + Roberto Palomba, 2007 - 2019

Gregg è realizzata in vetro soffiato a bocca e la sua forma organica ricorda un grande ciottolo levigato dall'acqua. La versione terra è proposta con diffusore medio o grande, con base in tre diversi colori per molteplici possibilità di ambientazione.

Gregg is made using mouth-blown glass and its organic shape resembles a large pebble smoothed by water. The floor version is available with a medium or large diffuser and the base comes in three different colours, able to meet the needs of various settings.

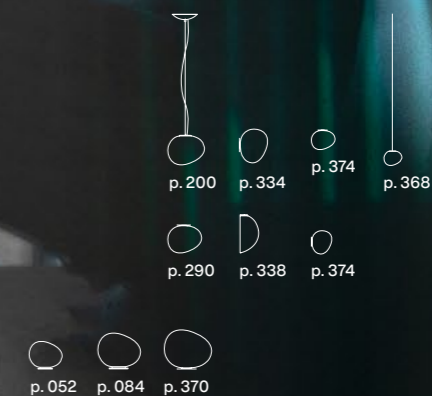


Vetro soffiato acidato e metallo verniciato.
Blown acid-etched glass and coated metal.

Colori — Colors
Vetro: bianco. Montatura: bianco, oro, grafite.
Glass: white. Frame: white, gold, graphite.



Collection

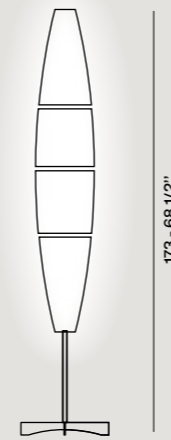


Discover more



L'inconfondibile diffusore di Havana è formato da quattro segmenti tenuti insieme da piccoli ganci metallici. Un design affusolato che ricorda la forma di un sigaro, da cui ironicamente prende il nome. Havana ha uno stile senza età e si colloca facilmente in qualsiasi ambiente, diffondendo attorno a sé una luminosità calda e soffusa.

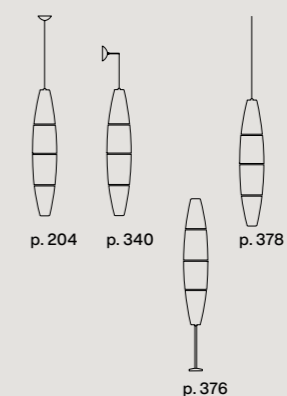
The unmistakable Havana diffuser is made up of four segments, held together by small metal hooks. The tapered design recalls the shape of a cigar, from which it ironically takes its name. Havana has timeless style and blends in easily with any room, diffusing a warm and soft light all around.



35 - 13 3/4"

Polietilene stampato ad iniezione e metallo verniciato o cromato.
Injection moulded polyethylene and coated or chromed metal.

Colori — Colors
Diffusore: bianco.
Montatura: alluminio, cromo.
*Diffusor: white.
Frame: aluminium, chrome.*

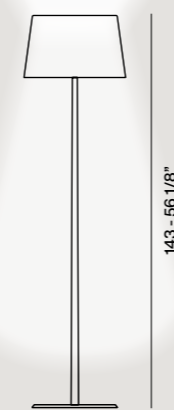
**Collection**

Discover more



La lampada da terra Lumiere XXL è un modello dall'eleganza ricercata, adatta sia per la lettura che per l'illuminazione d'interni. Il diffusore in prezioso vetro soffiato è disponibile in bianco e in un grigio molto contemporaneo che appare freddo a lampada spenta, per riempirsi di calore quando è accesa.

The Lumiere XXL floor lamp offers refined elegance, suitable as both a reading light and to light up the room. The diffuser, made from precious blown glass, is available in white and in a very modern grey colour, which may appear cold when the lamp is turned off, only to fill with warmth when switched on.



37 - 14 5/8"

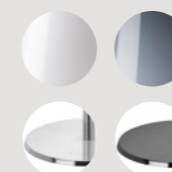
143 - 56 1/8"

Vetro soffiato e metallo verniciato o metallo cromato.
Blown glass and varnished or chromed aluminium and metal.

Colori — Colors
Vetro: bianco, grigio freddo.
Montatura: alluminio, cromo nero.
*Glass: white, cool grey.
Frame: aluminium, black chrome.*

Collection

Discover more




p. 294



p. 346



p. 060-062-068

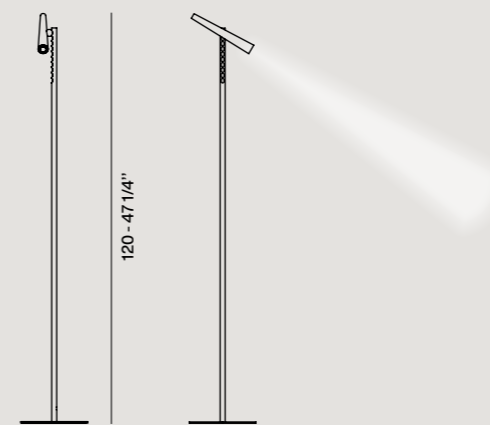


p. 072



La forza invisibile di una calamita sferica unisce lo stelo al compatto corpo illuminante, permettendo di orientarlo come una torcia. La sua luce intensa, concentrata e puntuale può essere direzionata a piacimento, perfetta per la lettura o un'illuminazione diffusa.

The invisible force of a spherical magnet connects the stem to the compact diffuser, allowing it to be directed like a torch. Its intense, concentrated and focused light can be easily directed at will, perfect for reading or for a diffused lighting effect.



20 - 7 7/8"

Acciaio verniciato, ABS e supermagnete in terre rare.
Coated steel, ABS and super magnet made of "rare earth".

Colori — Colors
Bianco, nero.
White, black.



Collection

Discover more



p. 076



Mite, design Marc Sadler, 2000

Ha dimensioni importanti e un design seducente e slanciato, realizzata con un innovativo mix di fibra di vetro e fili di carbonio o Kevlar®. Vincitrice del premio Compasso d'Oro ADI. Garantisce un ottimo illuminamento, proiettando un intenso e caldo fascio luminoso verso il soffitto.

The Mite floor lamp boasts significant dimensions and a seductive, slender design, made with an innovative mix of fibreglass and carbon thread or Kevlar®. Winner of the ADI Compasso d'Oro design award, this lamp guarantees excellent lighting, projecting an intense and warm beam towards the ceiling.



Compasso D'Oro 2001



22 - 8 5/8"

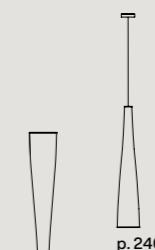
Tessuto di vetro con fibra di carbonio o Kevlar®, metallo nichelato, acciaio e alluminio (LED).
Fiber glass fabric with Kevlar® or carbonium thread, nickel-plated metal, steel and aluminium (LED).

Colori — Colors
 Giallo, nero.
Yellow, black.



Kevlar® is a Dupont registered trademark.

Collection



p. 124

Discover more



Mite Anniversario nasce per celebrare i vent'anni dal Compasso d'Oro ADI del 2001 a Mite. Volumetricamente è identica all'originale, ma il filo di carbonio è più sottile ed è montato con una spirale più ampia che procede addensandosi verso il basso. La base è in marmo Marquina e la finitura del corpo della lampada è opaca. Offre ampia distribuzione luminosa e totale illuminazione del diffusore.

Mite Anniversario was born to celebrate twenty years since the 2001 ADI Compasso d'Oro award. The volume of the lamp is identical to the original Mite, but the carbon thread is thinner and is mounted on a wider spiral that becomes denser as it converges towards the base in Marquina marble. The finish of the lamp body is matte. It offers wide light distribution and a total illumination of the diffuser.



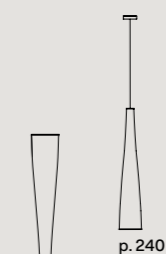
22 - 8 5/8"

Tessuto di vetro e fibra di carbonio, marmo nero, acciaio e alluminio.
Fiber glass fabric and carbonium thread, black marble aluminium and metal.

Colori — Colors
Anniversario.



Collection



p. 122

p. 240

Discover more



Orbital

Floor

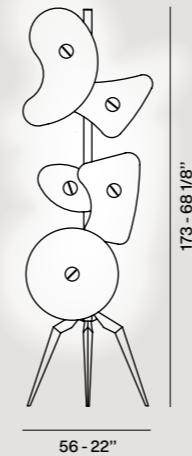




Orbital, design Ferruccio Laviani, 1992

Una vera e propria icona del design dell'illuminazione, che arreda con la forza di una scultura. Il caratteristico treppiede in lamiera e una composizione di sagome irregolari in vetro, bianche o multicolori, diffondono un segnale grafico e luminoso inconfondibile nello spazio.

A true icon of lighting design, decorating the room with the power of sculpture. The distinctive tripod made of metal sheet and the composition of irregular white or multi-coloured glass shapes make an unmistakable mark in any room, in terms of both design and lighting effect.



Vetro serigrafato e metallo verniciato.
Silkscreen-printed glass and varnished metal.

Colori — Colors
Bianco, colorato.
White, colored.



Collection



p. 314

Discover more

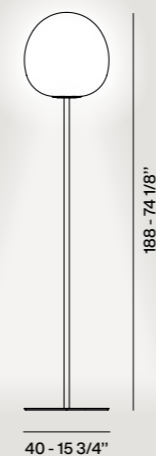




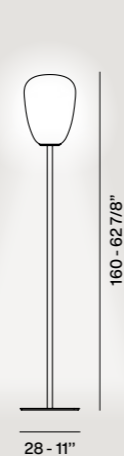
Si ispira alle lampade di carta della tradizione orientale ma è realizzata in un prezioso vetro soffiato a bocca arricchito da sottili incisioni - che ricordano il gesto della molatura - frutto di un sapiente lavoro artigiano. Le linee orizzontali sono al contempo decoro e filtrano la luce, che si diffonde calda e soffice nell'ambiente. Base in tre diversi colori.

Rituals is inspired by traditional, oriental paper lanterns, but is made of precious, mouth-blown glass enriched by subtle engravings - reminiscent of the grinding technique - the result of skilled craftsmanship. The horizontal lines are a decorative feature and filter the light at the same time, spreading a warm and soft lighting effect throughout the room. Base available in three different colors.

Rituals XL

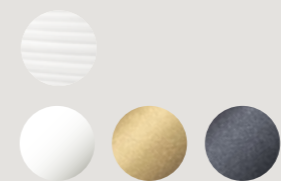


Rituals 1

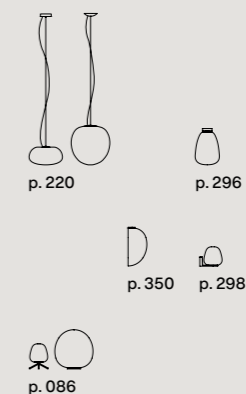


Vetro soffiato satinato inciso e metallo verniciato.
Blown engraved satin glass and coated metal.

Colori — Colors
Vetro: bianco. Montatura: bianco, oro, grafite.
Glass: white. Frame: white, gold, graphite.



Collection



Discover more

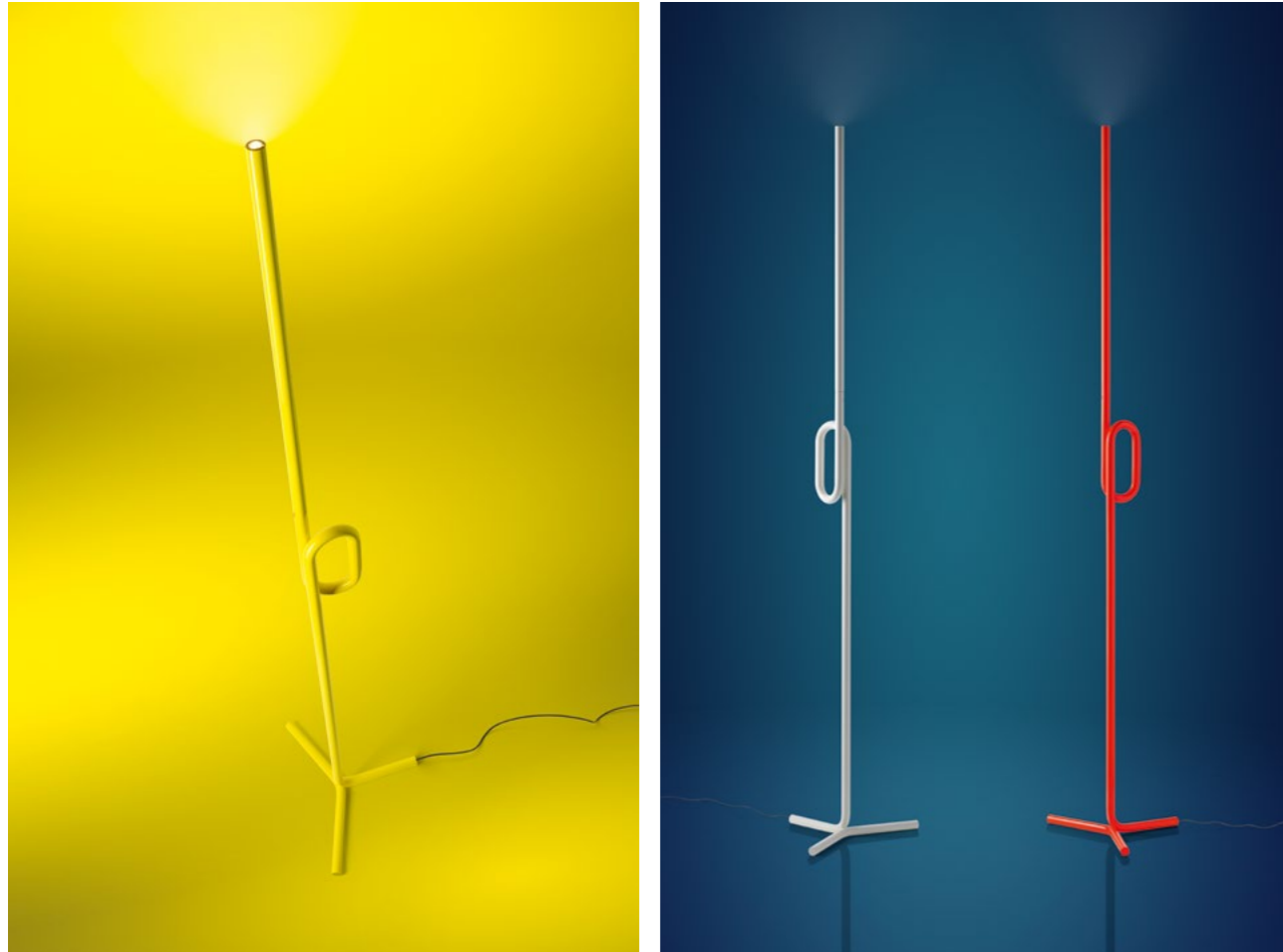


Tobia



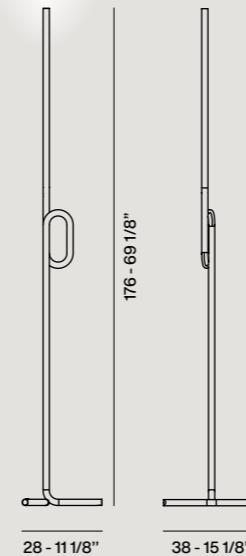
Floor





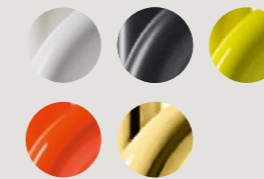
Esile e di ingombro contenuto, facile da spostare grazie al nodo centrale che invita alla presa, proietta una luce potente diretta verso l'alto. Dotata di touch dimmer che consente 4 step di variazione dell'intensità luminosa. Un punto luce dalle grandi prestazioni, in cui il colore ne sottolinea o mimetizza la presenza.

Slender and compact in size and simple to move around thanks to its easy-to-grip central knot, this lamp provides powerful upward lighting. Touch dimmer providing 4 different luminous intensity settings. A high-performance light point, whose colour can either highlight or camouflage its presence.



Metallo e alluminio verniciato o dorato.
Varnished or gold painted metal and aluminum.

Colori — Colors
Bianco, nero, giallo fluo, arancione fluo, oro.
White, black, fluo yellow, fluo orange, gold.



Collection



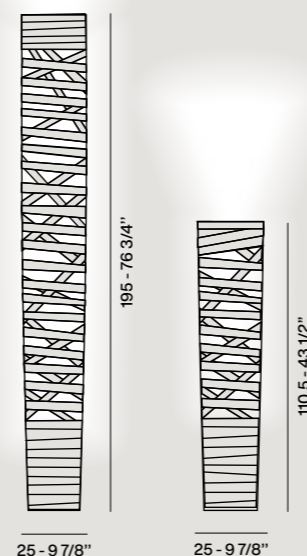
p. 354

Discover more



Un nastro di fibra di vetro e resina intrecciato con apparente casualità crea uno straordinario gioco di luci e ombre. Ha due sorgenti luminose con accensione separata: quella inferiore illumina l'interno, sottolineando l'intreccio, mentre quella superiore produce un'illuminazione riflessa verso il soffitto.

Fibreglass and resin woven together in a seemingly casual way, creating an extraordinary play on light and shadows. The Tress floor lamp has two light sources with separate controls: the lower one illuminates the interior, highlighting the weave, while the upper one creates a lighting effect that is reflected up towards the ceiling.

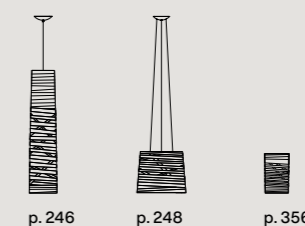


Materiale composito su base di fibra di vetro laccato, metallo verniciato e alluminio.
Compound material on lacquered glass fibre base, coated metal and aluminium.

Colori — *Colors*
Bianco, nero, greige.
White, black, greige.



Collection



Discover more



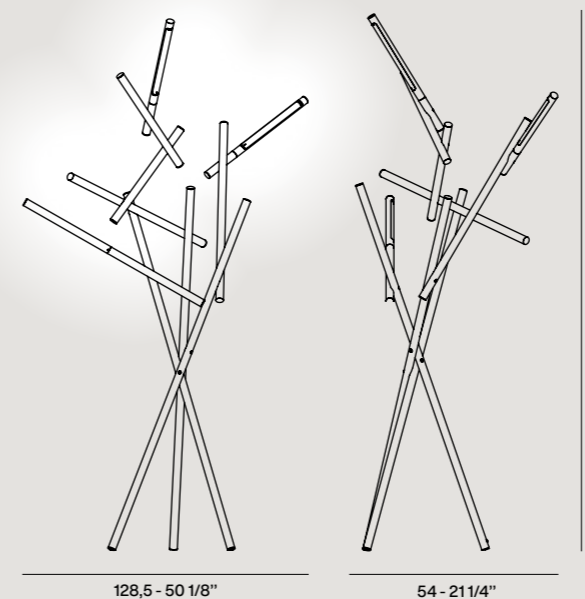


Tuareg, design Ferruccio Laviani, 2013

Floor

La lampada da terra Tuareg è una composizione tridimensionale che ricorda un assemblaggio di rami e canne - come un'opera di land art. È dotata di tre sorgenti luminose a LED con accensione indipendente e orientabili fino a 350° per variare l'effetto luminoso.

The Tuareg floor lamp is a three-dimensional composition that brings to mind an assembly of branches and sticks – just like a real piece of land art. It has three LED light sources that can be switched on and off separately and adjusted by up to 350° in order to vary the lighting effect.



Alluminio verniciato e policarbonato.
Varnished aluminium and polycarbonate.

Colori — Colors
Arancio, cromo nero.
Orange, black chrome.



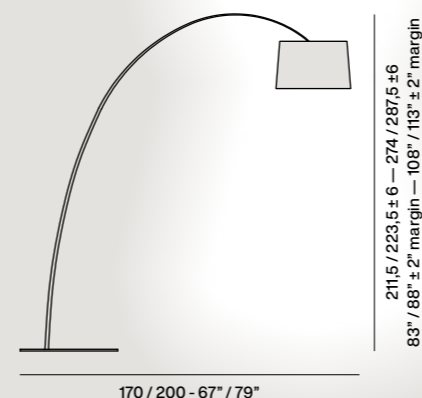
Discover more





Sospesa su uno stelo in materiale composito, flessibile come una canna da pesca e regolabile in altezza, Twiggy è un'idea semplice e geniale, divenuta un'icona Foscarini. Garantisce un'illuminazione diretta nell'area sottostante e diffonde verso l'alto un'accogliente luce d'ambiente. Il gruppo LED in un corpo unico offre una luce uniforme.

Suspended on a stem made of composite material, flexible like a fishing rod and with adjustable height, Twiggy has a simple yet brilliant design, which has become a Foscarini icon. Twiggy guarantees direct lighting to the area underneath it and diffuses a warm, ambient light upwards. The LED grouping reflect a uniform light.

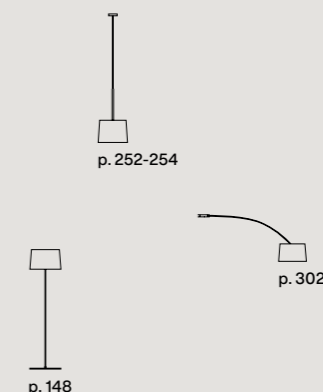


Materiale composito su base di fibra di vetro laccato, PMMA, policarbonato, metallo verniciato e alluminio.
Varnished fibreglass based composite material, PMMA, polycarbonate, coated metal and aluminium.

Colori — *Colors*
Bianco, nero, cremisi, greige, grafite, burgundy.
White, black, crimson, greige, graphite, burgundy.



Collection



Discover more



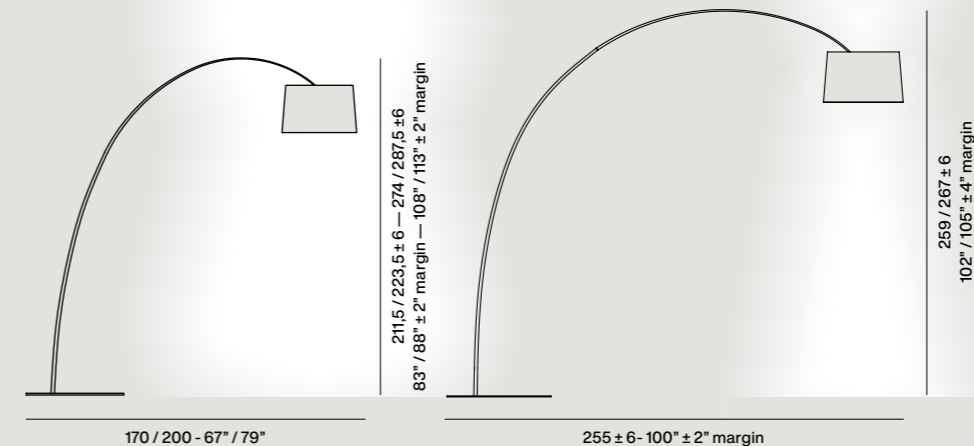


Perfetta per inserimenti in ambienti dove si desidera creare un'atmosfera raffinata, con un sapore morbido e rilassato. Lo stelo flessibile in fibra di carbonio si combina con un diffusore in legno dallo spessore incredibilmente sottile. Disponibile in versione Oak in legno chiaro o con finitura Rosewood che si distingue per la tonalità più scura, molto calda, esaltata dalle naturali venature del legno.

Perfect for use in spaces where the objective is a refined, soft and relaxing atmosphere. The flexible carbon fiber stem is combined with a diffuser in incredibly thin wood. Available in a light Oak version or with Rosewood finish which stands out for its darker, very warm tone, enhanced by the natural grain of the material.

Twiggy Wood

Twiggy Wood Elle

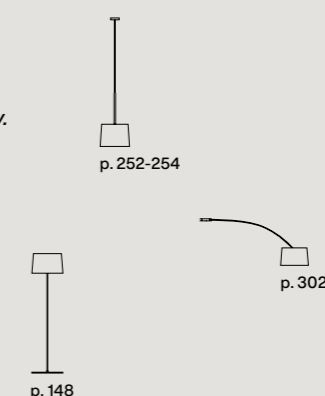


Rovere sbiancato o palissandro. PMMA, policarbonato, metallo verniciato e alluminio.
Limed oak or rosewood. PMMA, polycarbonate, coated metal and aluminium.

Colori — Colors
Diffusore: rovere, palissandro. Montatura: nero, greige, burgundy.
Diffuser: oak, rosewood. Frame: black, greige, burgundy.



Collection



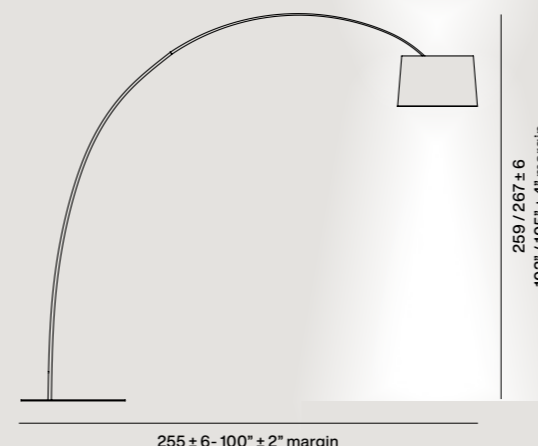
Discover more





Una lampada che ha fatto della flessibilità eletta a segno grafico il suo elemento distintivo, oggi diventa ancora più flessibile. Twiggy Elle arricchisce la famiglia traducendo in una funzione totalmente nuova il carattere distintivo di Twiggy. La nuova asta porta il diffusore ancora più lontano rispetto alla base. Un nuovo decentramento del punto luce che la rende perfetta per illuminare un tavolo.

A lamp which has made gracefully graphic flexibility its distinguishing feature has today become even more flexible. Twiggy Elle supplements the family, transferring the distinctive personality of Twiggy into a totally new function. The new rod takes the diffuser even further away from the base. A new off-centre light point, which makes it perfect for lighting a table.

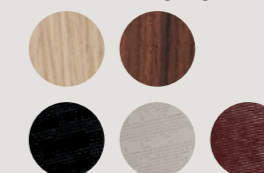


Materiale composito su base di fibra di vetro laccato. Rovere sbiancato o palissandro. PMMA, policarbonato, metallo verniciato e alluminio. *Varnished fibreglass based composite material. Limed durmast wood or rosewood. PMMA, polycarbonate, coated metal and aluminium.*

Colori — Colors
Twiggy Elle
Bianco, nero, cremisi, greige, grafite, burgundy.
White, black, crimson, greige, graphite, burgundy.



Colori — Colors
Twiggy Elle Wood
Diffusore: rovere, palissandro. Montatura: nero, greige, burgundy.
Diffuser: durmast, rosewood. Frame: black, greige, burgundy.



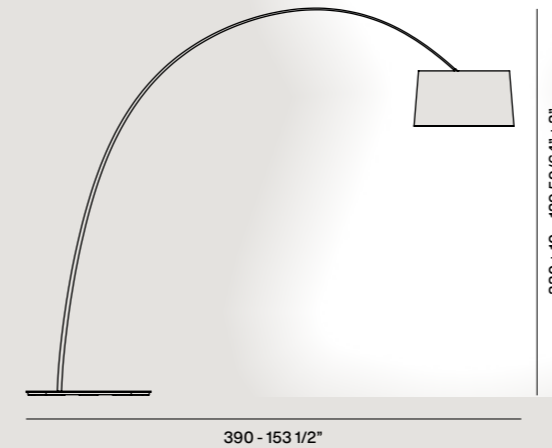
Discover more





Il segno sottile e flessibile dell'icona di design Twiggy diventa oversize in Twice as Twiggy, una lampada da terra progettata per i grandi spazi. Un sistema di contrappesi permette di scegliere l'altezza del paralume, dotato di due schede LED per una luce diretta verso il basso e diffusa verso l'alto.

The slender and flexible design of Foscari's iconic Twiggy becomes oversized with 'Twice as Twiggy': a floor lamp designed for large spaces. A system of counterweights allows you to choose the height of the lampshade, fitted with two LED boards for direct light pointing downwards and diffused light towards the ceiling.



Materiale composito su base di fibra di vetro laccato, PMMA, metallo verniciato e alluminio.
Coated fibreglass-based composite material, PMMA, coated metal and aluminium.

Colori — *Colors*
Bianco, nero, greige.
White, black, greige.



Collection



p. 256

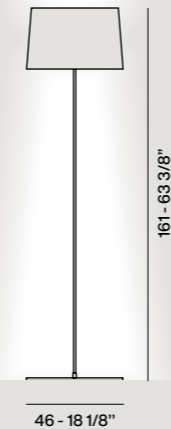
Discover more





Il concetto formale di leggerezza dell'iconica Twiggy viene declinato in questa versione da lettura dallo stelo sottile e dall'ampio diffusore che illumina efficacemente verso il basso e verso l'alto.

The lightweight design concept of the iconic Twiggy is transformed into a reading light, featuring a slender stem and large diffuser that effectively provides both downlighting and uplighting.



Materiale composito su base di fibra di vetro verniciato, policarbonato e metallo verniciato.
Coated fibreglass based composite material, polycarbonate and coated metal.

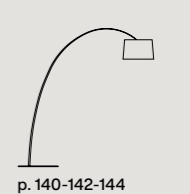
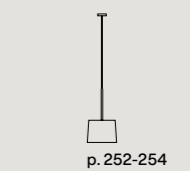
Colori — Colors
Twiggy Lettura
Bianca, nera, greige, burgundy.
White, black, greige, burgundy.



Colori — Colors
Twiggy Lettura Rosewood
Diffusore: palissandro.
Montatura: greige, burgundy.
Diffuser: rosewood. Frame: greige, burgundy.
Twiggy Lettura Oak
Diffusore: rovere. Montatura: greige, nero, burgundy.
Diffuser: oak. Frame: greige, black, burgundy.



Collection



Discover more



p. 302

Uptown, design Ferruccio Laviani, 2019

Una lampada-scultura dalla presenza totemica e di grande impatto. Suggestiva già da spenta, quando si illumina diventa protagonista assoluta dello spazio: la composizione di tre corpi in lastre di vetro si caricano di luce, che viene proiettata verso l'alto.

A totemic lamp-sculpture with great visual impact. Already striking when switched off, when switched on UpTown plays the starring role in the room: the composition made up of three sheet-glass shapes fills with light, which is projected upwards.



193 - 75 7/8"

25 - 9 7/8"

Vetro temperato serigrafato, PMMA e acciaio inox.
Serigraphed tempered glass, PMMA and stainless steel.

Colori — Colors
Multicolore: giallo / rosso / blu.
Multicolour: yellow / red / blue.

Discover more



154	Allegro	214	Plass
156	Allegretto	216	Plena
160	Aplomb + Aplomb mini	220	Rituals
168	Aplomb Large	220	Rituals XL
170	Big Bang + L + XL	222	Satellight
174	Birdie	224	Spokes
176	Buds	230	Sun-Light of Love
180	Bump	234	Supernova
184	Caboche Plus	238	Tartan
188	Chouchin	240	Tite
192	Chouchin Reverse	242	Tonda
194	Chouchin Bianco	246	Tress
198	Gem	248	Tress grande
200	Gregg	250	Troag LED
204	Havana	252	Twiggy
206	Le Soleil	254	Twiggy Wood
208	Lightweight	256	Twice as Twiggy
210	Nuée	258	Uto

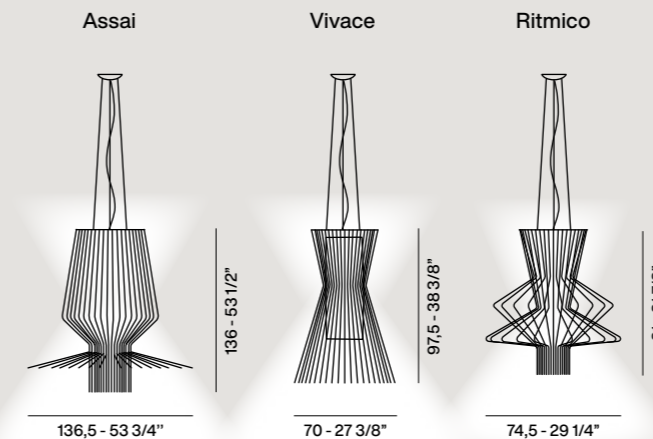


Allegro, design Atelier Oi, 2007

Suspension

Una collezione che prende forma grazie alla forza di gravità, con linee metalliche che disegnano la luce ed emettono suoni se sfiorate. A questa “musicalità” si ispira il nome delle tre versioni, di dimensioni importanti, con finiture e forme diverse. Illuminazione diffusa, diretta verso il basso e riflessa a soffitto.

A collection that takes form thanks to the force of gravity, with metal lines that shape the light and emit sounds when touched. This “musical” character is behind the name of the three versions, large in size, with different finishes and forms. Diffused light, directed downward and reflected from the ceiling.



Alluminio verniciato e metallo cromato.
Varnished aluminium and metal.

Colori — Colors
Assai oro, Vivace rame,
Ritmico grafite.
Assai gold, Vivace copper,
Ritmico graphite.



Discover more



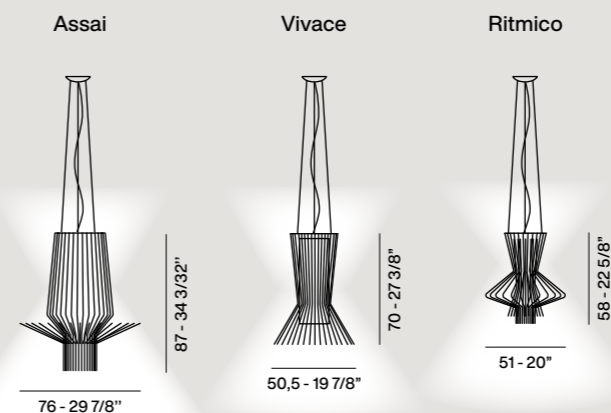
Allegretto



Suspension

Proporzioni e volumi studiati in funzione di una dimensione più contenuta. Un'armonia di sottili linee metalliche, che creano forme tridimensionali e giochi di luce ed ombre, in tre variazioni sul tema. Offre un'illuminazione diffusa, diretta verso il basso e riflessa a soffitto.

More compact proportions and volumes, designed to conserve the harmony of the slender metal lines that create three-dimensional forms and games of light and shadow, in three variations on the theme. For diffused lighting, directed downward and reflected from the ceiling.



Alluminio verniciato e metallo cromato.
Varnished aluminium and metal.

Colori — Colors
Assai oro, Vivace rame,
Ritmico grafite.
Assai gold, Vivace copper,
Ritmico graphite.



Discover more

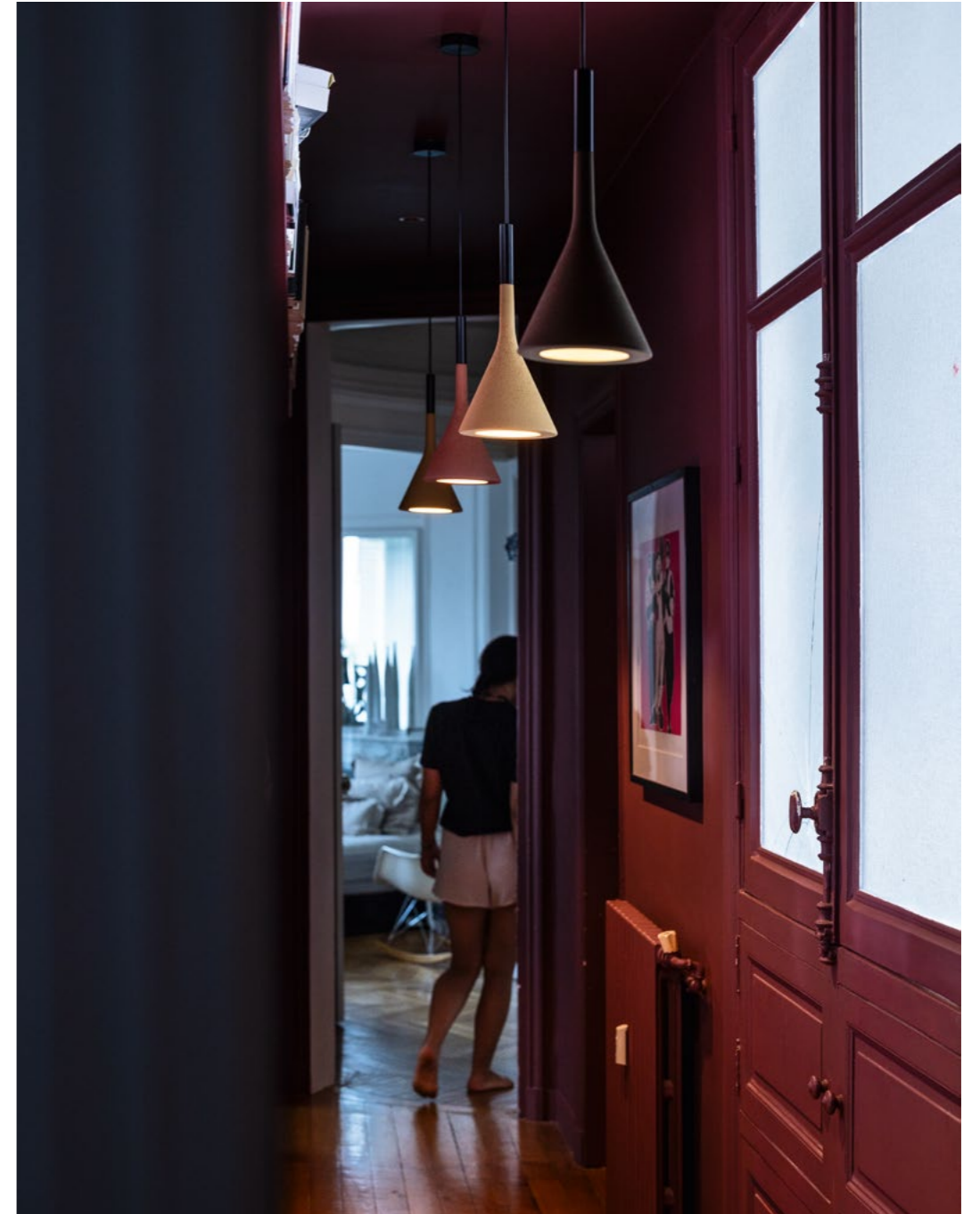


Aplomb



Foscarini — Collezioni

Suspension



Aplomb / Aplomb mini



Suspension





Una lampada in cemento dalle dimensioni contenute che proietta un fascio di luce diretta e puntuale sul piano sottostante. L'esclusivo amalgama di cemento, dall'aspetto materico al contempo grezzo e raffinato, è arricchito di pigmenti per ottenere le diverse colorazioni. Ancora più compatta la versione mini.

A lamp made of concrete, compact in size, to project a direct beam with precision onto the surface below. The exclusive concrete mix, with a simultaneously rugged and refined look, is enhanced by pigments to obtain different colours. The mini version is even more compact.

Aplomb



17 - 6 3/4"

36 - 14 1/8"

Aplomb mini



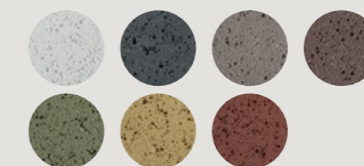
12 - 4 3/4"

20 - 7 3/4"

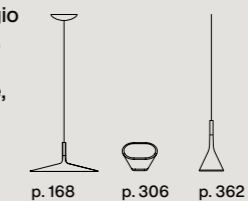
Cemento colato a mano e alluminio.
Hand pouring concrete and aluminium.

Colori — Colors

Aplomb: bianco, antracite, grigio cemento, marrone, verde oliva, giallo sabbia, rosso mattone.
Aplomb mini: bianco, antracite, grigio cemento, marrone.
Aplomb: white, anthracite, concrete grey, brown, olive green, sand yellow, brick red.
Aplomb mini: white, anthracite, concrete grey, brown.



Collection



p. 168

p. 306

p. 362

Discover more



Aplomb Large

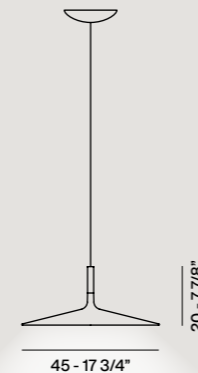


Suspension



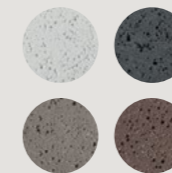
Spessori sottili, ampie dimensioni, una superficie materica ma piacevole al tatto: Aplomb Large rappresenta una sfida progettuale vinta grazie ad un processo totalmente artigianale. Con sorgente a LED integrato, diffonde un'illuminazione ad ampio raggio verso il piano sottostante.

Minimal thickness, ample size, a rugged surface, yet pleasing to the touch: Aplomb Large represents a design challenge resolved through a totally handmade process. With built-in LEDs, it spreads light in a large beam across the surface below.

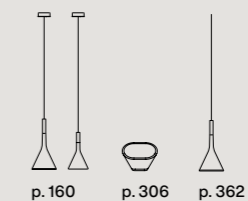


Cemento colato a mano, alluminio e policarbonato.
Hand pouring concrete, aluminium and polycarbonate.

Colori — Colors
Bianco, antracite, grigio cemento, marrone.
White, anthracite, concrete grey, brown.



Collection



Discover more

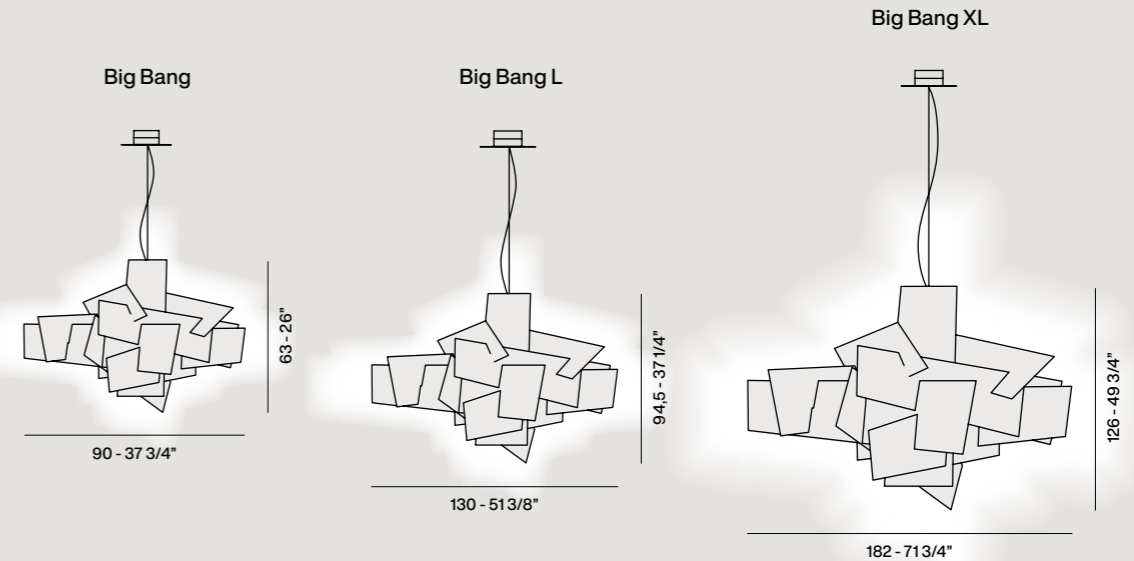






Intersezioni irregolari di piani nello spazio creano un volume di grande plasticità e impatto visivo. Offre una luce diretta sul piano inferiore e diffusa nell'ambiente. La particolare disposizione delle lastre in metacrilato garantisce il massimo della riflessione luminosa ed evita l'abbaglio.

Irregular intersections of planes in space create a vivid sculptural volume of great visual impact. The lamp provides direct lighting on the surface below and diffused lighting in the room. The particular arrangement of the methacrylate panels ensures maximum reflection while preventing glare.



Metacrilato e alluminio verniciato.
Methacrylate and varnished aluminium.

Colori — Colors
Bianco, rosso.
White, red.



Collection



p. 310

Discover more





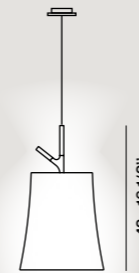
Birdie, design Ludovica + Roberto Palomba, 2013

Suspension

Reinterpretazione in chiave contemporanea della classica lampada con paralume, Birdie è leggera, familiare, caratterizzata dal richiamo di un ramoscello pronto ad accogliere un uccellino, da cui il nome. Il diffusore in policarbonato lascia filtrare una luce calda e intima nell'ambiente e la diffonde verso il basso.

A contemporary reinterpretation of the classic shaded lamp, Birdie is light, familiar, suggesting the image of a branch ready to welcome a bird – hence its name. The polycarbonate diffuser allows warm, intimate light to spread downward in the space.

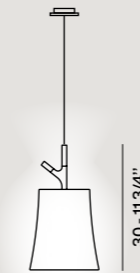
grande



25 - 9 7/8"

42 - 16 1/2"

piccola



17 - 6 7/8"

30 - 11 3/4"

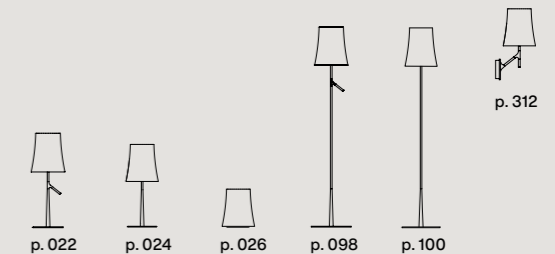
Policarbonato e metallo verniciato.
Polycarbonate and coated metal.

Colori — Colors
Bianco, grigio.
White, grey.



Collection

Discover more



Buds

Suspension





Una famiglia di lampade in diverse forme e tonalità, studiate anche per creare composizioni multiple. Protagonista è la raffinata ricchezza del vetro soffiato con una lavorazione artigianale a cinque strati. La versione bianco caldo appare bianca da spenta e avorio da accesa.

A family of lamps with different forms and tones, also developed to create multiple compositions. The protagonist is the refined beauty of blown glass, carefully crafted in five layers. The warm white version has a white hue when off, and an ivory colour when it is turned on.

Buds 1



26 - 10 3/8"

39,5 - 15 1/2"

Buds 2



41,5 - 16 3/8"

25 - 10"

Buds 3



30 - 11 7/8"

23 - 8 7/8"

Vetro soffiato.
Blown glass.

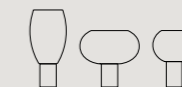
Colori — Colors

Buds 1 bianco caldo.
Buds 2 grigio, bianco caldo.
Buds 3 verde bambù,
bianco caldo.
*Buds 1 warm white.
Buds 2 grey, warm white.
Buds 3 bamboo green,
warm white.*



Collection

Discover more



p. 030

Bump

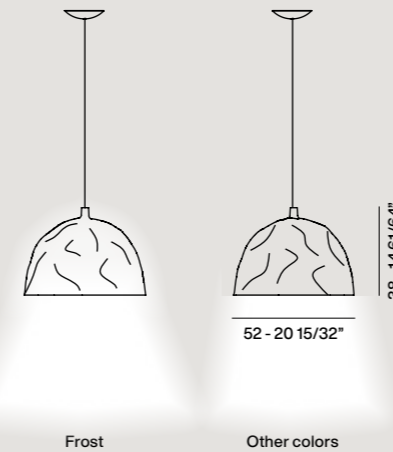
Suspension





Una lampada a cupola con superficie irregolare che illumina con efficacia il piano sottostante. Nella versione “frost” la luce è diretta verso il basso e diffusa nell’ambiente attraverso la calotta traslucida. Nelle versioni colorate opache la luce viene invece diretta solo verso il basso.

A dome lamp with an irregular surface that effectively illuminates the surface below it. In the “frost” version the light is aimed downward, while spreading into the room thanks to a translucent top. In the opaque colored versions the light is aimed only downward.



PMMA o ABS stampato e verniciato.
Varnished and moulded PMMA or ABS.

Colori — Colors
(Frost) trasparente satinato, oro, petrolio, nero.
(Frost) transparent satin, gold, petroleum blue, black.



Discover more



Caboche Plus



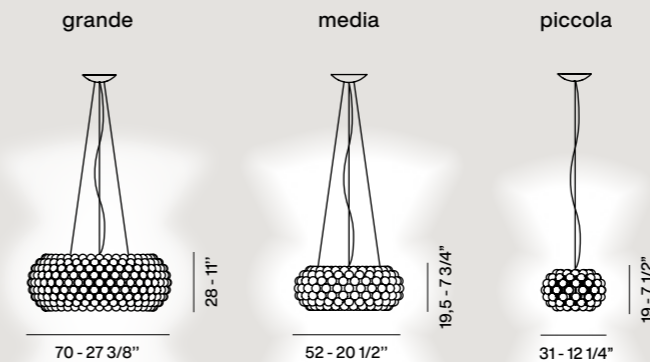
Suspension





Trasparenza, leggerezza formale e una luce brillante. La riprogettazione degli archetti, del sistema di aggancio "a baionetta" e delle sfere che sembrano galleggiare nel vuoto una volta montate, garantiscono un effetto di trasparenza totale molto suggestivo. Quando è accesa, la luce si diffonde senza interferenze illuminando l'ambiente a 360° con un fascio sia diretto sul piano sia riflesso verso l'alto.

Transparency, light shapes, and brilliant light. The redesign arches, the "twist lock" attachment system, and the spheres that appear to float in space once mounted, create a truly charming total transparency effect. When it is switched on, light spreads without interference through 360°, with a beam both directed below and upwards.

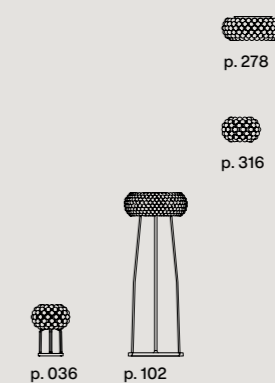


PMMA, policarbonato, metallo cromato e alluminio, vetro soffiato.
PMMA, polycarbonate, chromed metal and aluminium, blown glass.

Colori — Colors
Trasparente, grigio.
Transparent, grey.



Collection



Discover more



Chouchin

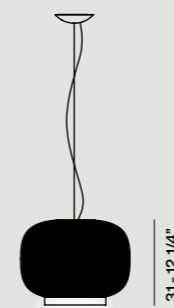
Suspension



Richiamo alle tipiche lanterne giapponesi, rivisitate in chiave contemporanea. Tre modelli - coordinabili tra loro - che giocano sul contrasto fra il vetro soffiato verniciato lucido, con colorazioni calde e pastose impermeabili alla luce e la parte inferiore bianca che si illumina e diffonde la luce verso il basso.

A reminder of typical Japanese lanterns, in a contemporary reinterpretation. The three coordinated models play with the contrast between glossy coated blown glass - in warm, creamy colours impermeable to light - and the white lower portion that glows, spreading light downward.

Chouchin 1



40 - 15 7/8"

31 - 12 1/4"

Chouchin 2



22 - 8 7/8"

43 - 17"

Chouchin 3



30 - 12"

25 - 9 7/8"

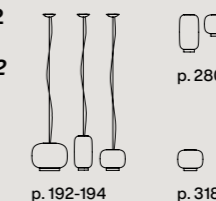
Vetro soffiato verniciato.
Lacquered blown glass.

Colori — Colors

Chouchin 1 arancio, Chouchin 2 verde, Chouchin 3 grigio.
Chouchin 1 orange, Chouchin 2 green, Chouchin 3 grey.



Collection



Discover more

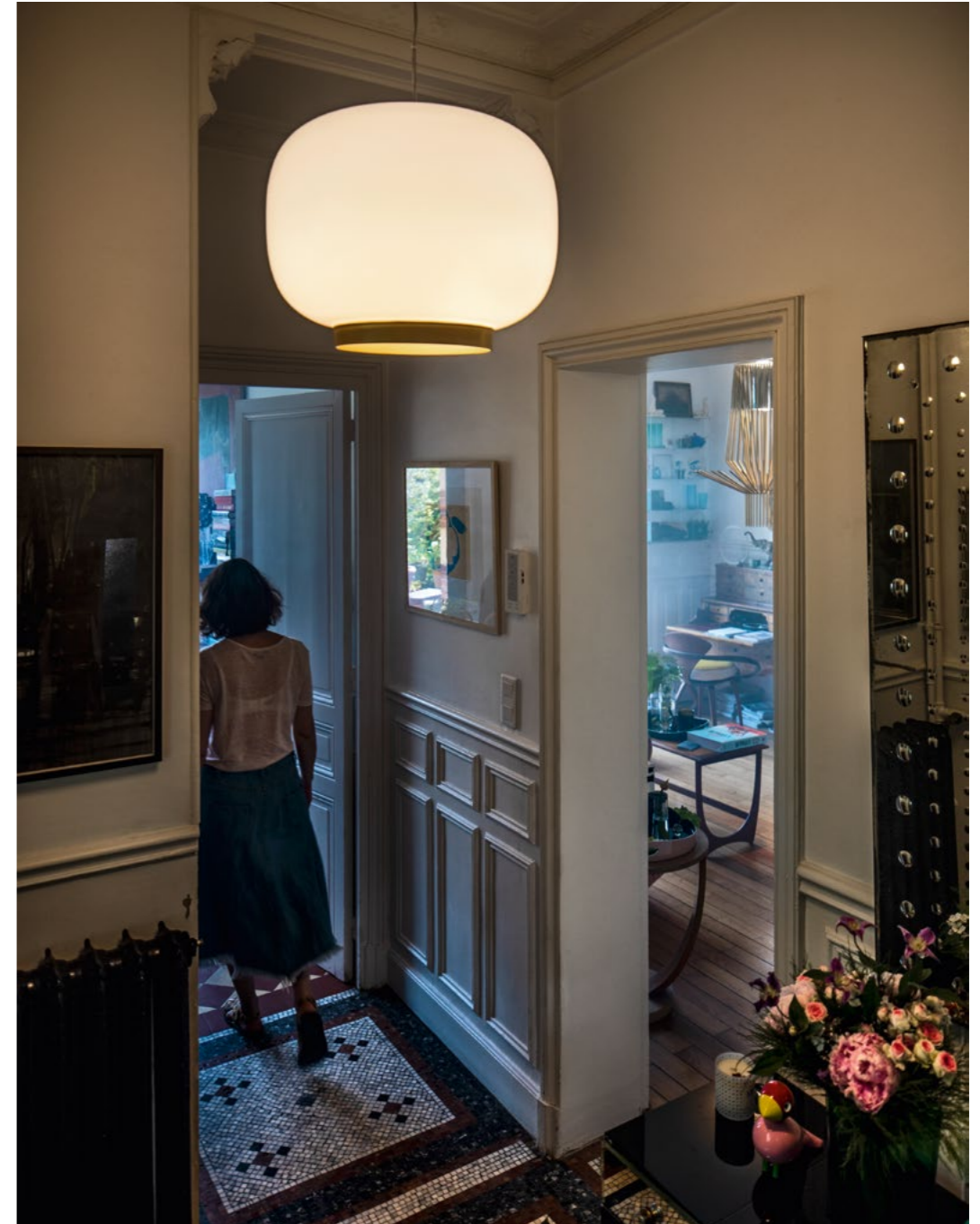


Chouchin Reverse



Foscarini — Collezioni

Suspension

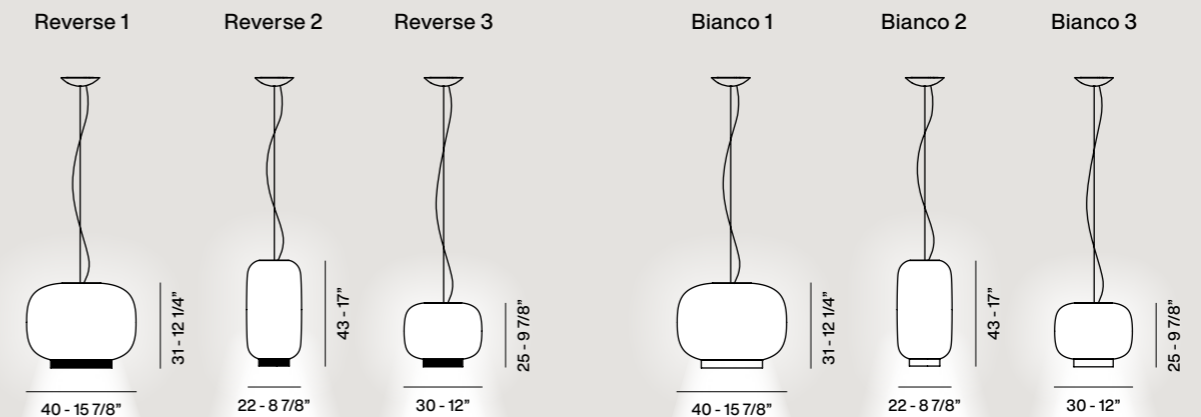






Rilettura contemporanea delle tradizionali lanterne giapponesi, Chouchin Reverse è caratterizzata dal colletto inferiore colorato e offre una luce diversa rispetto a Chouchin. Disponibile anche in una versione totalmente bianca. Il diffusore in vetro soffiato diffonde una luminosità solare e brillante nell'ambiente, oltre a dirigerla verso il basso.

A contemporary take on traditional Japanese lanterns, Chouchin Reverse stands out for its coloured lower border, providing a different kind of light with respect to Chouchin. Also available in a completely white version. The blown glass diffuser spreads sunny, bright light into the space, aiming the glow downward at the same time.



Reverse: vetro soffiato verniciato. Bianco: vetro soffiato.
Reverse: lacquered blown glass. Bianco: blown glass.

Colori — Colors
Reverse 1: bianco+arancio / bianco+oro, Reverse 2: bianco+verde / bianco+nero, Reverse 3: bianco+grigio.
Reverse 1: white+orange / white+gold, Reverse 2: white+green / white+black, Reverse 3: white+grey.
Bianco 1-2-3: bianco. White.



Collection
p. 280
p. 188
p. 318

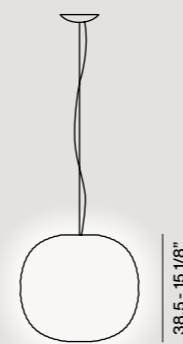
Discover more





Una vibrazione fluida sul vetro, una particolare lavorazione che la rende inconfondibile anche da spenta. Le sfaccettature tridimensionali, con linee che si intersecano sulla superficie, sono ottenute con la tecnica artigianale della soffiatura a bocca del vetro in uno stampo con incisioni.

A fluid vibration on glass, with special craftsmanship that makes it unique also when off. The three-dimensional facets, with lines intersecting on the surface, are made by blowing glass into an etched mould.



43 - 16 7/8"

Vetro soffiato in rilievo e acidato.
Blown acid-etched glass with reliefs.

Colori — Colors
Bianco. *White.*



Collection



p. 288



p. 330



p. 050

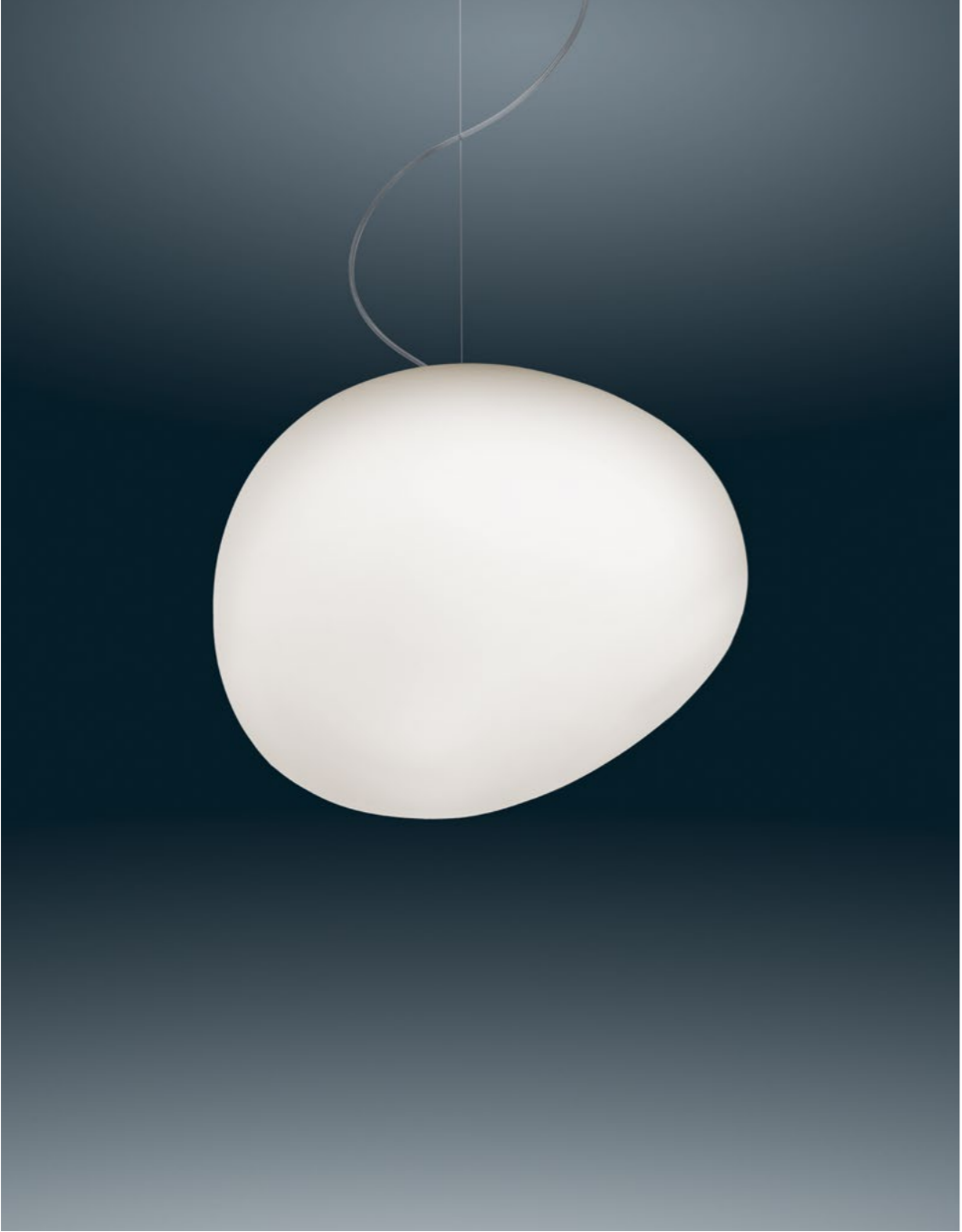


p. 112

Discover more



Gregg



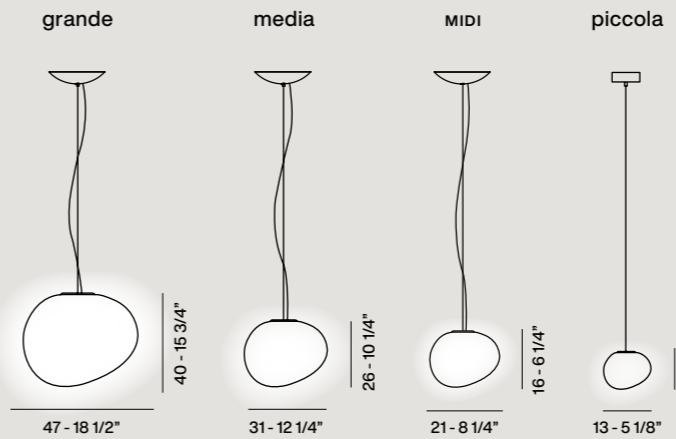
Suspension





Tra le collezioni più versatili e trasversali, si inserisce in ogni tipo di contesto. Il diffusore satinato bianco dalla forma organica e asimmetrica irradia una luce calda e uniforme. La forma chiusa la rende di facile inserimento anche su altezze diverse. In composizione si offre agli impieghi più sorprendenti.

One of the most versatile collections, ideal for insertion in any type of context. The white frosted shade with its organic, asymmetrical form emits warm, uniform light. The closed form makes it easy to insert at different heights. Arranged in compositions, it offers a surprising range of applications.

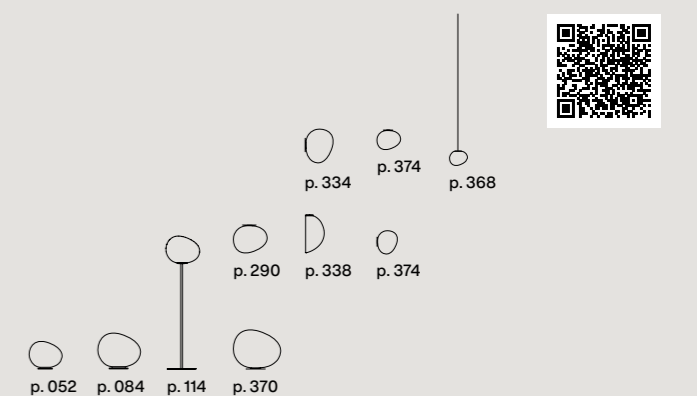


Vetro soffiato satinato.
Blown acid-etched glass.

Colori — Colors
Bianco. White.

Collection

Discover more



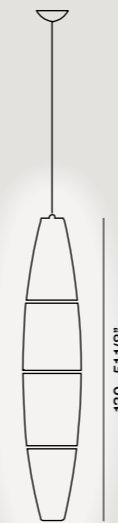


Havana, design Jozeph Forakis, 1993

Suspension

Con la sua inconfondibile forma a sigaro composta da quattro sezioni tenute insieme da piccoli ganci metallici, Havana è parte della collezione permanente del MoMa di New York. Una lampada che non si inserisce nello spazio, ma lo crea, diffondendo una luminosità calda e soffusa.

With its inimitable cigar shape composed of four segments held together by small metal fasteners, Havana is part of the permanent collection of MoMa New York. A lamp that is not inserted in space but creates it, spreading soft, warm light.



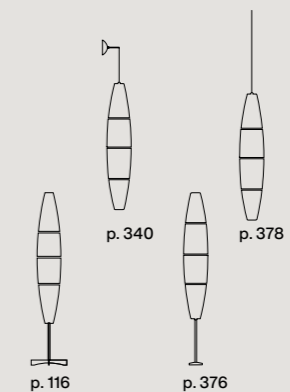
23 - 9 1/8"

Polietilene stampato ad iniezione e metallo verniciato.
Injection moulded polyethylene and coated metal.

Colori — *Colors*
Bianco. *White.*



Collection



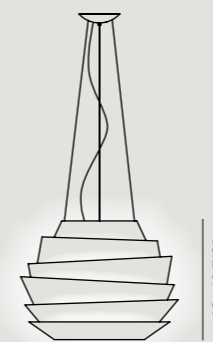
Discover more





Un'architettura sospesa che richiama il profilo del Guggenheim Museum di New York. Le fasce irregolari movimentano il volume e la rendono diversa a seconda del punto di vista, creando un particolarissimo gioco di luce riflessa e diffusa. Vero centro di attrazione visivo.

A suspended work of architecture, suggesting the profile of the Guggenheim Museum in New York. The irregular bands add dynamism to the volume and make its image differ depending on the vantage point, in a unique game of reflected and diffused light. A true focal point.



60,5 - 23 7/8"

Polietilene stampato ad iniezione e metallo verniciato.
Injection moulded polyethylene and coated metal.

Colori — Colors
Bianco. White.



Collection



p. 344

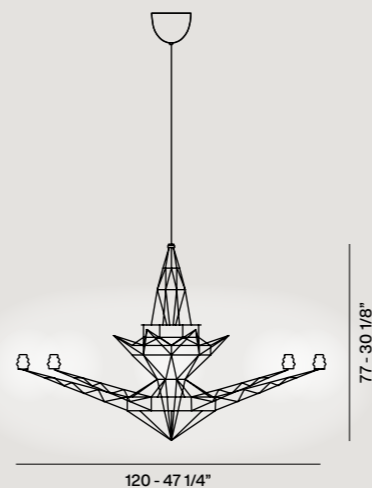
Discover more



Lightweight, design Tom Dixon, 1995

Il classico lampadario a bracci viene spogliato da tutti i decori: ne resta solo lo scheletro. Realizzata a mano saldando insieme centinaia di elementi, coniuga l'innovazione del segno e la tradizione di un processo produttivo semiartigianale. Otto piccoli diffusori in vetro soffiato acidato diffondono una luce intensa.

The classic chandelier with arms, stripped of all its decorations: only the skeleton remains. Crafted by hand by welding together hundreds of parts, it combines an innovative image with a semi-traditional production process. Eight small diffusers in etched blown glass propagate intense light.



Metallo anodizzato.
Anodized metal.

Colori — Colors
Anodizzato. Anodized.



Discover more



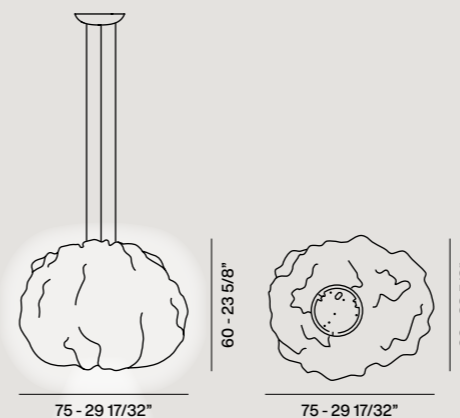
Nuée

Suspension



Una nuvola di luce da modellare a piacimento, realizzata in un tessuto tecnico tridimensionale, lavorato con una tecnologia che Foscarini introduce per prima nel settore dell'illuminazione. Leggera e aerea, ha una doppia illuminazione. La prima si sprigiona dall'interno della nuvola. Un secondo fascio è diretto verso il basso, per illuminare un piano d'appoggio o un camminamento.

A cloud of light to be modelled as you see fit, made with a technical three-dimensional fabric, processed using technology which Foscarini is the first to introduce in the lighting industry. Light-weight and suspended, it offers double lighting. The first light is shed from inside the cloud. The second beam is directed down, to light a supporting surface or walkway.



Tessuto tridimensionale
tecnico e metallo verniciato.
*Three-dimensional technical
fabric and varnished metal.*

Colori — *Colors*
Bianco. *White.*



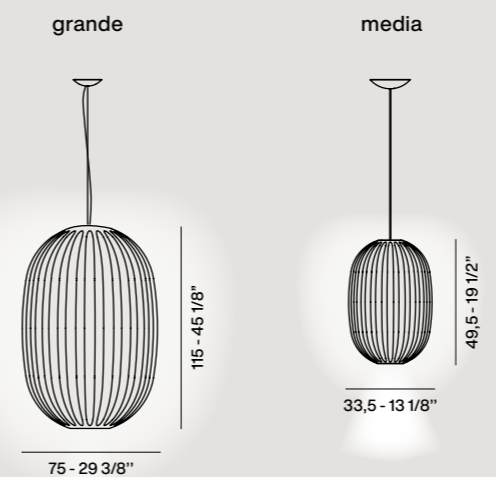
Discover more





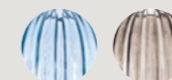
Si ispira nella forma e nei colori alle perle di vetro della tradizione veneziana, ma è realizzata in polycarbonato trasparente. La superficie è caratterizzata da lievi imperfezioni che ricordano il vetro artigianale e fanno vibrare la luce. Due misure per progetti su grande scala o più contenuti.

Based on the form and colours of the glass beads of the Venetian tradition, but made with transparent polycarbonate. The surface has slight imperfections that suggest handcrafted glass, making the light vibrate. In two sizes for large-scale or more compact projects.



Policarbonato stampato in rotazionale e alluminio.
Rotational moulded polycarbonate and aluminium.

Colori — Colors
Azzurro (solo versione media), grigio.
Light blue (only medium version), grey.



Collection

Discover more

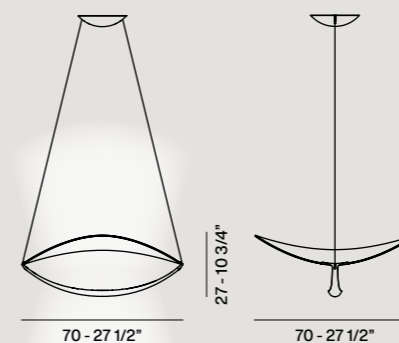


p. 082



Dalla luna prende il nome e una luce che affascina: riflessa sul piano sottostante e diffusa verso il soffitto grazie allo speciale telo con alta riflettività della luce. Illumina completamente una stanza mantenendosi morbida e avvolgente, senza abbagliare. Grande nelle dimensioni, ma dalla presenza dinamica e leggera.

Like the fascinating light of the full moon: reflected on the surface below, or spreading toward the ceiling thanks to a special high-reflection fabric. The lamp brightens the whole room with its soft, enveloping presence, completely free of glare. Large in size, but light and dynamic.



PVC e alluminio verniciati.
Varnished PVC and aluminium.

Colori — Colors
Bianco. White.

Discover more

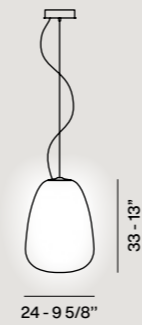




Ricordano le lanterne in carta della cultura orientale, ma sono realizzate in un vetro soffiato a bocca dall'aspetto piacevolmente gessoso, arricchito da sottili incisioni, in forme diverse e complementari. Le linee orizzontali sono al contempo decoro e filtrano la luce, che si diffonde calda e soffice nell'ambiente.

Resembling the paper lanterns of oriental culture, but made with handcrafted blown glass with a pleasantly chalky appearance enhanced by slender incisions, in different and complementary forms. The horizontal lines are decorative but also filter the light, spreading its soft warmth into the room.

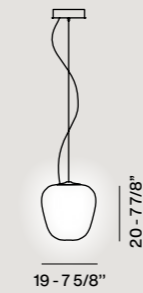
Rituals 1



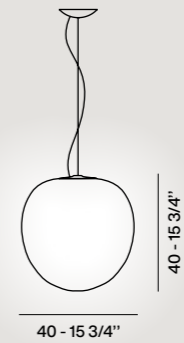
Rituals 2



Rituals 3



Rituals XL



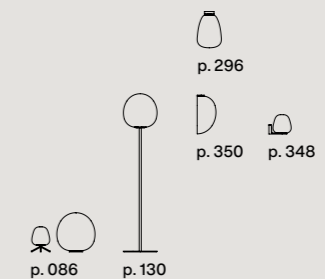
Vetro soffiato satinato inciso e metallo verniciato.
Blown engraved satin glass and coated metal.

Colori — Colors
Bianco. White.



Collection

Discover more



Un design poetico e sorprendente, completamente realizzato in vetro soffiato a bocca. Il diffusore satinato bianco è inserito in un corpo trasparente che, come per magia, sembra sostenere il cuore luminoso e trattenerne la luce. Trasmette una luminosità calda, morbida e gentile che non abbaglia gli occhi.

A poetic, surprising design made completely in handcrafted blown glass. The white frosted diffuser is inserted in a transparent body that seems to levitate the luminous core and capture its light as if by magic. The lamp transmits warm, soft light, completely without glare.



36 - 14 1/8"

41 - 16 1/8"

Vetro cristallo soffiato a bocca e vetro incamiciato acidato.
Hand-blown crystal glass and cased acid-etched glass.

Colori — *Colors*
Bianco e trasparente.
White and transparent.



Collection



p. 352



p. 092

Discover more



Spokes

Suspension



Spokes



Foscarini — Collezioni

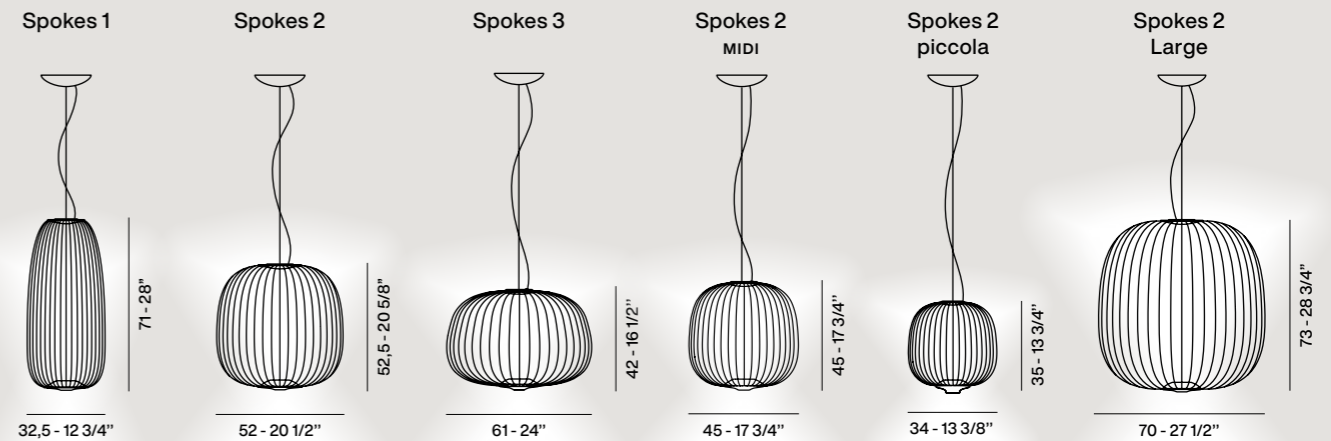
Suspension





Volumi leggeri che contengono la luce e al contempo la lasciano filtrare nello spazio. La doppia sorgente luminosa a LED illumina perfettamente il piano sottostante, creando contemporaneamente magici giochi di luce e ombre su pareti e soffitto. Ampia versatilità offerta da forme, misure e colori differenti.

Light volumes that contain light and at the same time allow it to flow into space. The double LED source lights the surface below perfectly, while creating magical games of light and shadow on the walls and ceiling. A truly versatile model, thanks to the range of forms, sizes and colours.



Acciaio e alluminio verniciati.
Varnished steel and aluminium.

Colori — Colors
Bianco, nero, grafite, oro, rame.
White, black, graphite, gold, copper.



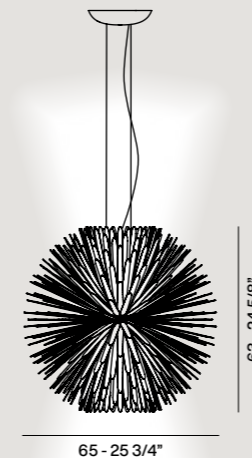
Discover more





Come il sole dai contorni incandescenti e inafferrabili, non ha un preciso inizio né fine: 390 raggi in acciaio danno vita a una lampada a sospensione scultorea e dal forte impatto. La doppia fonte luminosa - diretta verso il basso e indiretta verso l'alto - la rende perfetta sia per illuminare una stanza sia per creare un'atmosfera intima attorno ad un tavolo. Due finiture colore ne modulano il carattere.

Like the sun with its molten, unfathomable contours, it has no precise beginning or end. 390 steel rays give life to a suspension lamp with great presence and personality. The double light source - directed downward and diffused upward - makes it perfect to light a room or to create a cosy atmosphere around a table. Two colour finishes set the tone of the lamp.



65 - 25 3/4"

Acciaio e alluminio verniciati a liquido.
Varnished steel and aluminium.

Colori — Colors
Bianco, oro.
White, gold.



Discover more

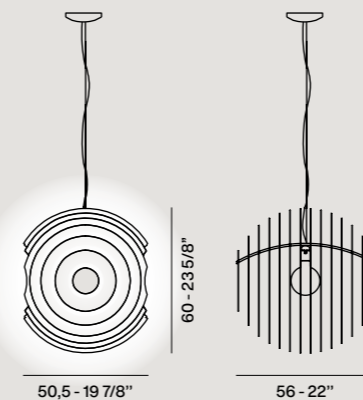




Supernova, design Ferruccio Laviani, 2000

Sorprendente volume sferico creato dalla composizione di piani bidimensionali: 7 coppie di dischi diversi agganciati a un'asta. Il particolare design dei dischi metallici crea un affascinante effetto di luce riflessa e un chiaroscuro di ombre. La lampadina al centro è come il nucleo incandescente di un pianeta.

A surprising spherical volume created by assembling two-dimensional planes: 7 pairs of different disks, attached to a rod. The particular design of the metal disks creates a fascinating effect of reflected light and shadows. The light source at the centre is like the incandescent nucleus of a planet.



Alluminio naturale o verniciato.
Lacquered or natural aluminium.

Colori — Colors
Alluminio, fucsia.
Aluminium, fuchsia.



Discover more





Vetro soffiato ricco di personalità, ottenuto con una particolare tecnica di soffiatura a bocca, che ricrea l'effetto del famoso tessuto scozzese. Caratterizzata da linee e pieghe che ne percorrono la superficie, generando un gioco grafico di luci e ombre. Illuminazione diretta verso il basso e soffusa nell'ambiente.

Blown glass with a vivid personality, crafted by hand with a particular technique to recreate the effect of the famous Scottish fabric. The lines and folds running across the surface generate the graphic interplay of lights and shadows. Direct downward lighting combined with soft ambient glow.



40 - 15 3/4"

Vetro soffiato in rilievo e acidato.
Blown acid-etched glass with reliefs.

Colori — *Colors*
Bianco. *White.*



Collection



p. 300

Discover more





Tite, design Marc Sadler, 2000

Suspension

Realizzata con un innovativo mix di fibra di vetro e filo di carbonio nero: una sintesi geniale che funge da decoro grafico e struttura funzionale. Vincitrice del premio Compasso d'Oro ADI. Quando è accesa la luce dà risalto al decoro e proietta verso il basso un intenso e caldo fascio luminoso.

Made with an innovative mixture of fiberglass and black carbon thread: a brilliant combination that provides a decorative graphic effect along with a functional structure. Winner of the Compasso d'Oro ADI award. When the light is on the pattern is enhanced, as the lamp projects an intense, warm downward beam.

Compasso
D'Oro 2001

Tite 1



21 - 8 3/8"

115 - 45 1/4"

Tite 2



21 - 8 3/8"

55 - 21 5/8"

Tessuto di vetro con fibra di carbonio e metallo nichelato.
Fiberglass fabric with carbonium thread and nickel-plated steel.

Colori — Colors
Nero. *Black.*



Collection

Discover more

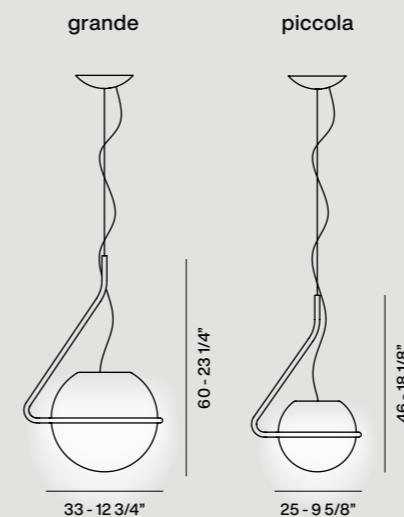


p. 122-124



Tonda affascina per il suo stato di equilibrio, apparentemente illogico: il sostegno è disassato eppure sostiene la sfera, grazie al contrappeso dato dal tubo di metallo colorato e piegato. Una scultura luminosa che non è mai uguale a sé stessa, nemmeno nella qualità della luce diffusa emessa dal vetro soffiato a bocca e sfumato.

Tonda is fascinating for its apparently illogical balance: the support is out of alignment, yet it sustains the sphere thanks to a counterweight provided by the coloured and shaped metal tubing. A luminous sculpture that is never precisely equal, not even in the quality of the diffused light emitted by the handmade blown and shaded glass.



Vetro soffiato sfumato e acciaio verniciato.
Shaded blown glass and varnished metal.

Colori — Colors
Arancio, bianco, titanio.
Orange, white, titanium.



Discover more





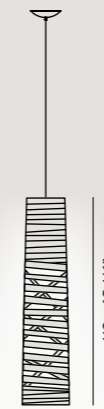
Tress, design Marc Sadler, 2009

Suspension

Magico intreccio di pieni e vuoti, ottenuta con un processo artigianale avvolgendo un nastro in materiale composito con ordinata casualità. Forte presenza scenica e inconfondibile segno grafico, è studiata per illuminare un'area specifica nello spazio sottostante.

A magical weave of full and empty zones, obtained with a process of workmanship in which a ribbon of composite material is wrapped in a random yet orderly way. A striking theatrical presence with an inimitable graphic image, the lamp has been developed to light a specific area below.

media



25 - 9 7/8"

110 - 43 1/4"

piccola



23 - 9 1/4"

61 - 24"

mini



20 - 7 3/4"

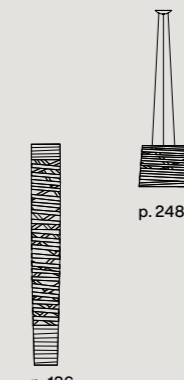
43 - 17"

Materiale composito su base di fibra di vetro verniciato e metallo cromato.
Coated fibreglass-based composite material and chromed metal.

Colori — *Colors*
Bianco, nero, greige.
White, black, greige.



Collection



p. 136



p. 248



p. 356

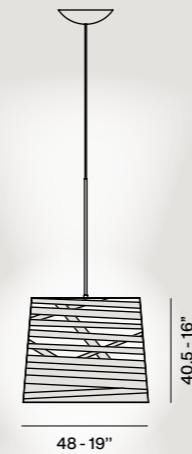
Discover more





Un nido di luce fatto di trame e intrecci che sono struttura e decoro insieme. Ottenuta con un processo artigianale avvolgendo un nastro in materiale composito con ordinata casualità. Si caratterizza per una diffusa propagazione della luce verso il basso.

A nest of light made of weaves and wrappings that act as both structure and decoration. Produced with a craft process in which a ribbon of composite material is wound in a random yet orderly way. The light is mostly directed downward.

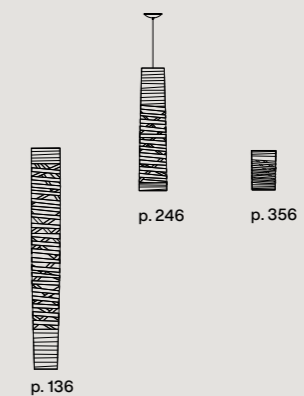


Materiale composito su base di fibra di vetro verniciato, vetro soffiato, metallo cromato e alluminio.
Coated fibreglass-based composite material, blown glass, chromed metal and aluminium.

Colori — *Colors*
Bianco, nero, greige.
White, black, greige.



Collection

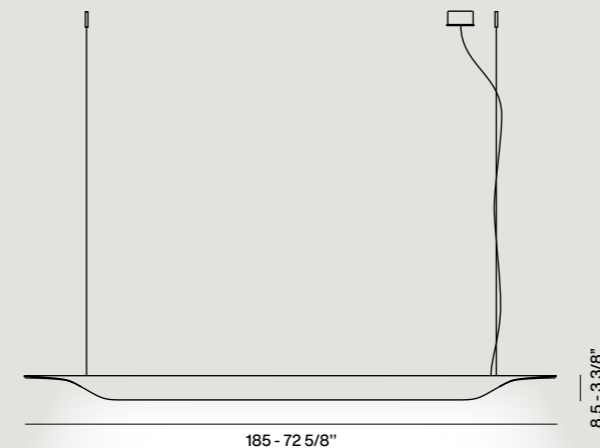


Discover more



Troag coniuga una luce dalle elevate prestazioni con la raffinata eleganza del legno. Dal segno leggero e lineare, è realizzata in legno multistrato, curvato a caldo e lavorato con una particolare fresatura che crea un profilo dinamico, enfatizzato dalle venature del legno. La luce è concentrata verso il basso.

Completely redesigned in technical terms to offer a new LED version, Troag combines high-performance light with the refined elegance of wood. An original suspension lamp with a light, linear image, made of thermo-curved plywood shaped by a particular milling technique to create a dynamic silhouette underscored by the wood grain. The light is aimed downward.



Multistrato di legno di frassino curvato e PMMA.
Curved ash plywood and PMMA.

Colori — Colors
Legno naturale, nero.
Natural wood, black.



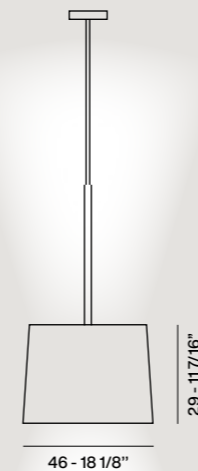
Discover more





Il design lineare e inconfondibile della lampada Twiggy, realizzata in materiale composito su base di fibra di vetro laccato, trova nella versione a sospensione ulteriori possibilità di utilizzo. Illumina l'area sottostante e diffonde verso l'alto un efficace illuminamento per riflessione, grazie alla trasparenza del disco superiore.

The unmistakable linear design of the Twiggy lamp, made in composite material on a coated fiberglass base, meets with ulterior usage possibilities in the suspension model. It brightens the area below while spreading light upward to reflect on the ceiling, thanks to the transparency of the upper disk.

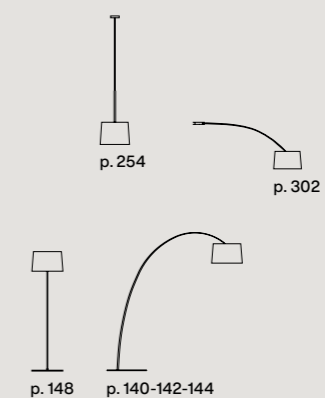


Materiale composito su base di fibra di vetro verniciato, policarbonato, PMMA e acciaio.
Coated fibreglass based composite material, PMMA, polycarbonate and steel.

Colori — *Colors*
Bianco, nero, burgundy.
White, black, burgundy.



Collection



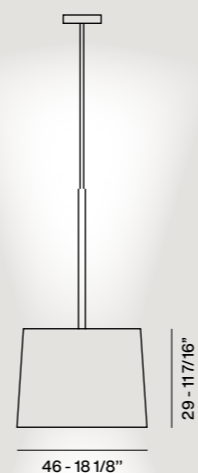
Discover more





Lampada a sospensione che porta il calore e il sapore del legno negli ambienti più diversi. Offre un'intensa illuminazione verso il basso e diffonde verso l'alto una luce d'ambiente. Un piccolo stelo in materiale composito collocato sul filo elettrico ne caratterizza il design.

A suspension lamp that brings the warmth and flair of wood into the most diverse settings. It provides intense down light while diffusing an ambient up light. A small rod in composite material placed on the electrical cable distinguishes its design.

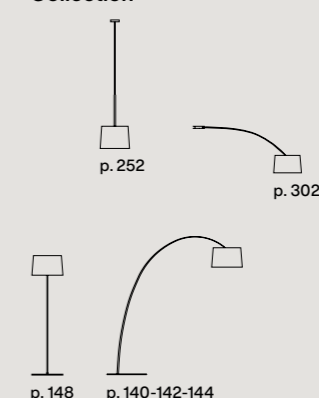


Rovere sbiancato o palissandro. PMMA, policarbonato e alluminio.
Limed oak or rosewood. PMMA, polycarbonate and aluminium.

Colori — Colors
Diffusore: rovere, palissandro.
Montatura: greige, burgundy.
Diffuser: oak, rosewood. Frame: greige, burgundy.



Collection



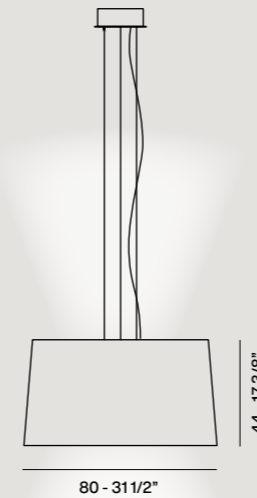
Discover more





Dalle dimensioni generose, realizzata in materiale composito su base di fibra di vetro laccato, mantiene tutta la leggerezza del progetto originale. Con due schede LED illumina l'area sottostante e diffonde verso l'alto un efficace illuminamento per riflessione.

With ample measurements, made in composite material on a coated fiberglass base, this model conserves all the lightness of the original project. The two LED sources light the area below while spreading light upward to reflect on the ceiling.



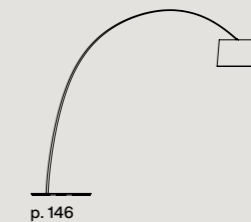
Materiale composito su base di fibra di vetro laccato, PMMA e acciaio.
Coated fibreglass-based composite material, PMMA and steel.

Colori — *Colors*
Bianco, nero, cremisi, greige.
White, black, crimson, greige.



Collection

Discover more



p. 146

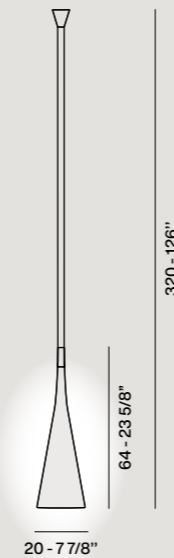


Uto, design Lagranja Design, 2005

Suspension

Una lampada fuori dagli schemi. Flessibile e trasformista può essere utilizzata in interno e in esterno, modellandola a seconda delle esigenze e ispirazioni personali. Può essere usata da appoggio, appesa alla parete o al soffitto, ambientata in soggiorno o in giardino.

A truly unconventional product. Flexible and ready to be transformed, it can be used indoors or outdoors, shaped to respond to personal needs and inspirations. The lamp can be placed hung from the wall or ceiling, inserted in a living area or a garden.



Elastomero termoplastico e policarbonato.
Thermoplastic elastomer and polycarbonate.

Colori — *Colors*
Bianco, giallo, arancio.
White, yellow, orange.



Collection



p. 390

Discover more



262	Rosoni multipli <i>Multiple canopies</i>	270	Kit decentramento <i>Decentralization kit</i>
-----	---	-----	--

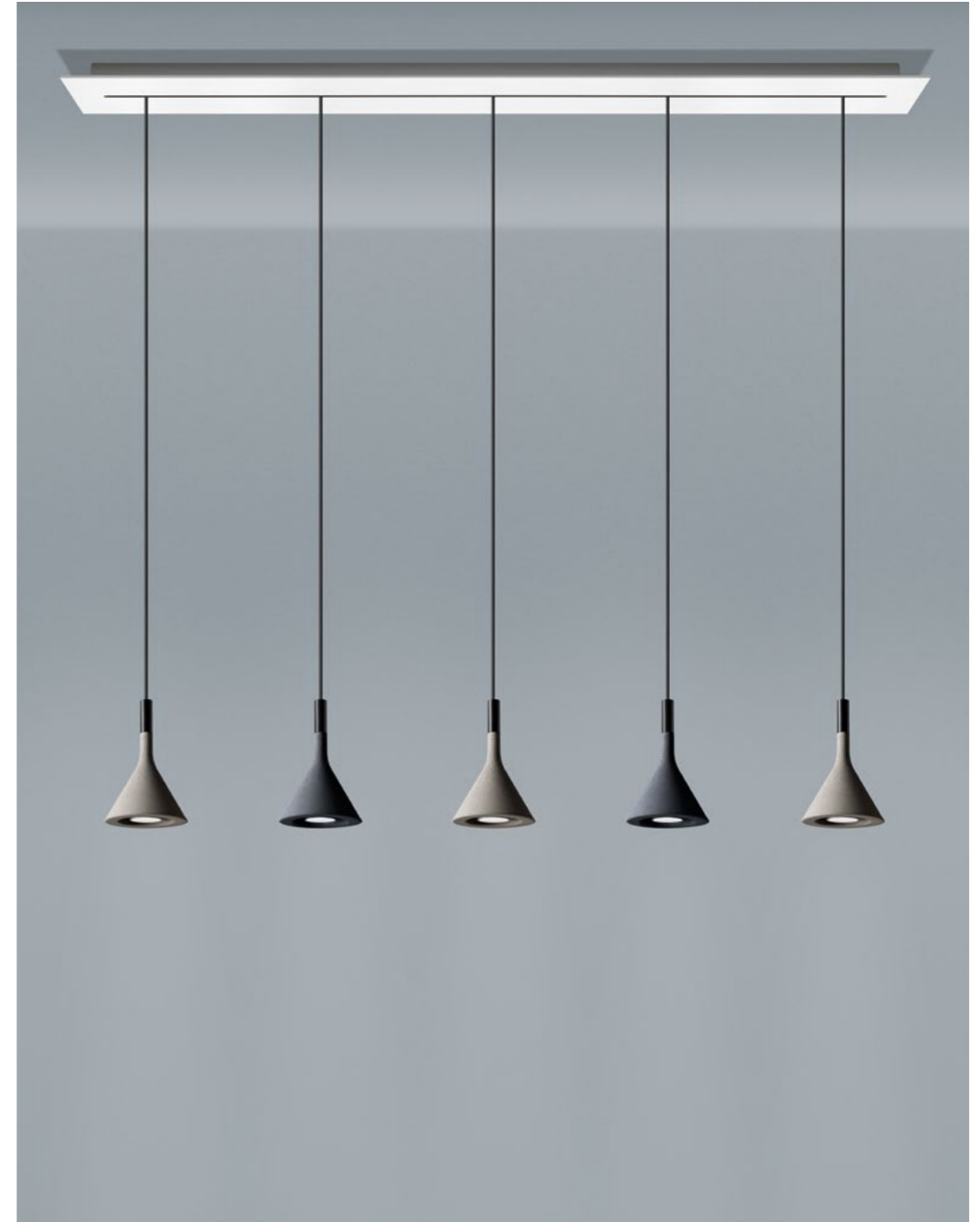
Rosoni multipli
/ Multiple canopies



Rituals

Foscarini — Collezioni

Accessories



Aplomb mini

Rosoni multipli
/ *Multiple canopies*



Chouchin / Chouchin Reverse

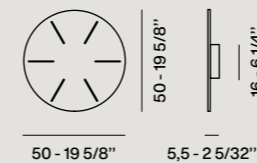
Rosoni multipli / *Multiple canopies*

Accessories

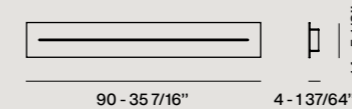
Modularità, libertà di composizione, possibilità di creare scenari di luce sempre differenti. Grazie ai rosone multipli – pensati per comprendere fino a 6/9 sospensioni e disponibili in versione tonda e lineare – si possono creare cascate luminose di grande impatto. Una soluzione tecnica che coniuga funzionalità e armonia, per effetti scenografici unici.

Modularity, freedom of composition and possibility of always creating different lighting scenarios. Thanks to Foscarini's multiple canopies - designed to include up to 6/9 suspensions and available in a round and linear version - it is possible to create luminous cascades of great impact. A technical solution that combines functionality and harmony, for unique scenographic effects.

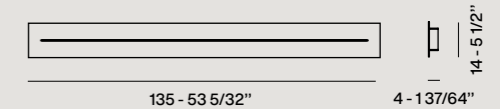
tondo / *round*



lineare / *linear*
L 90 - 35"



lineare / *linear*
L 135 - 53"

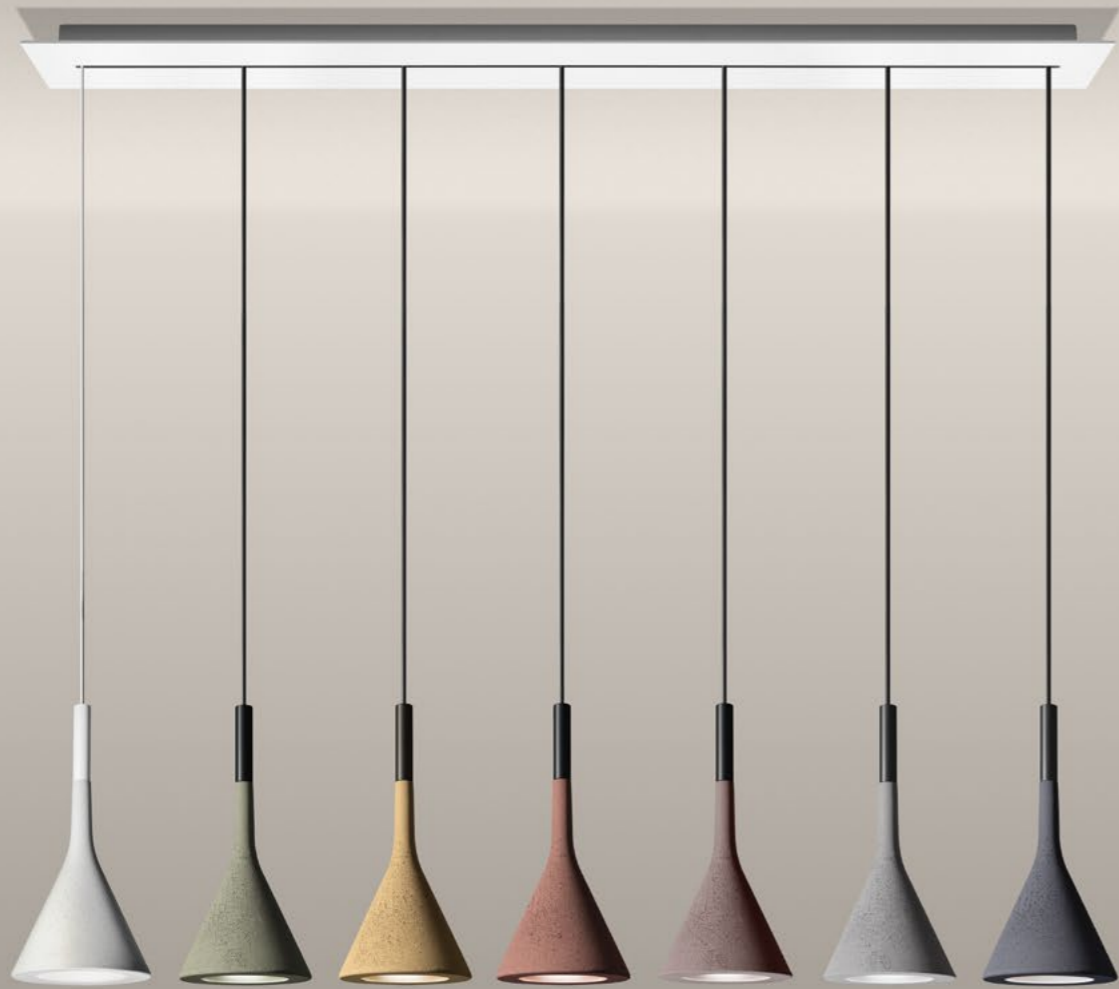


Metallo verniciato.
Max: 30 kg.
Laquered metal.
Max: lbs 66.14.

Colori — *Colors*
Bianco. *White.*



Rosoni multipli
/ Multiple canopies

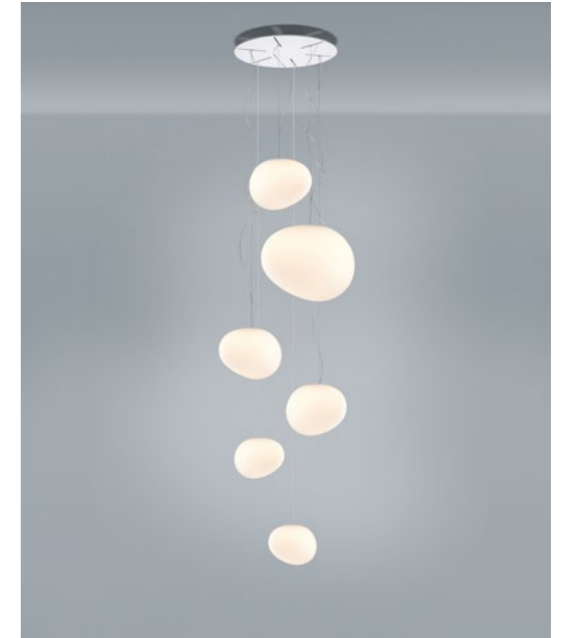


Aplomb

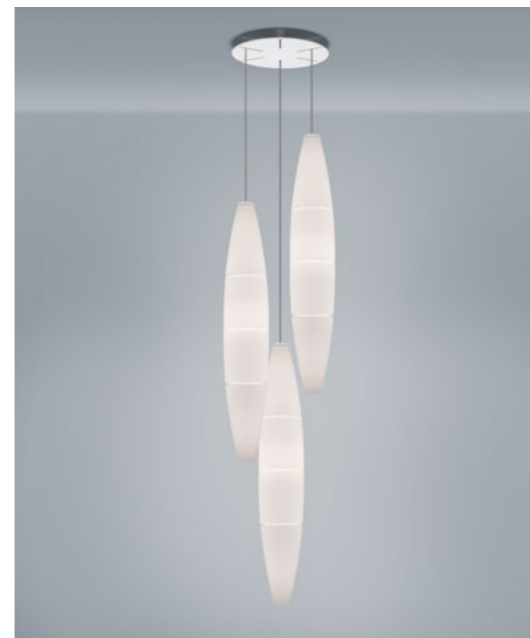
Accessories



Birdie



Gregg



Havana



Rituals XL

Rosoni multipli
/ Multiple canopies



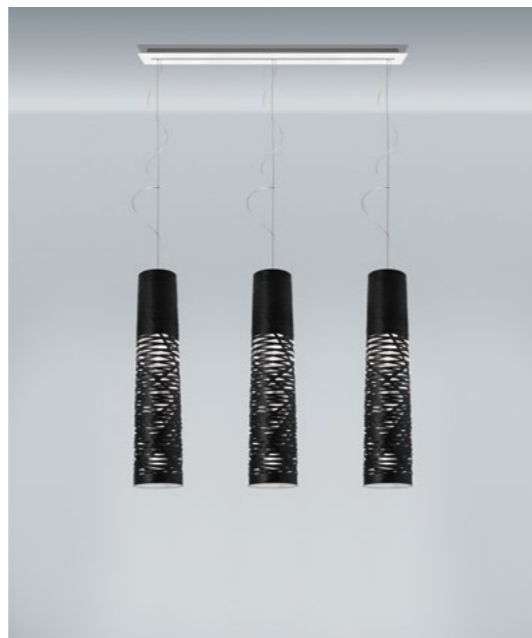
Gregg piccola



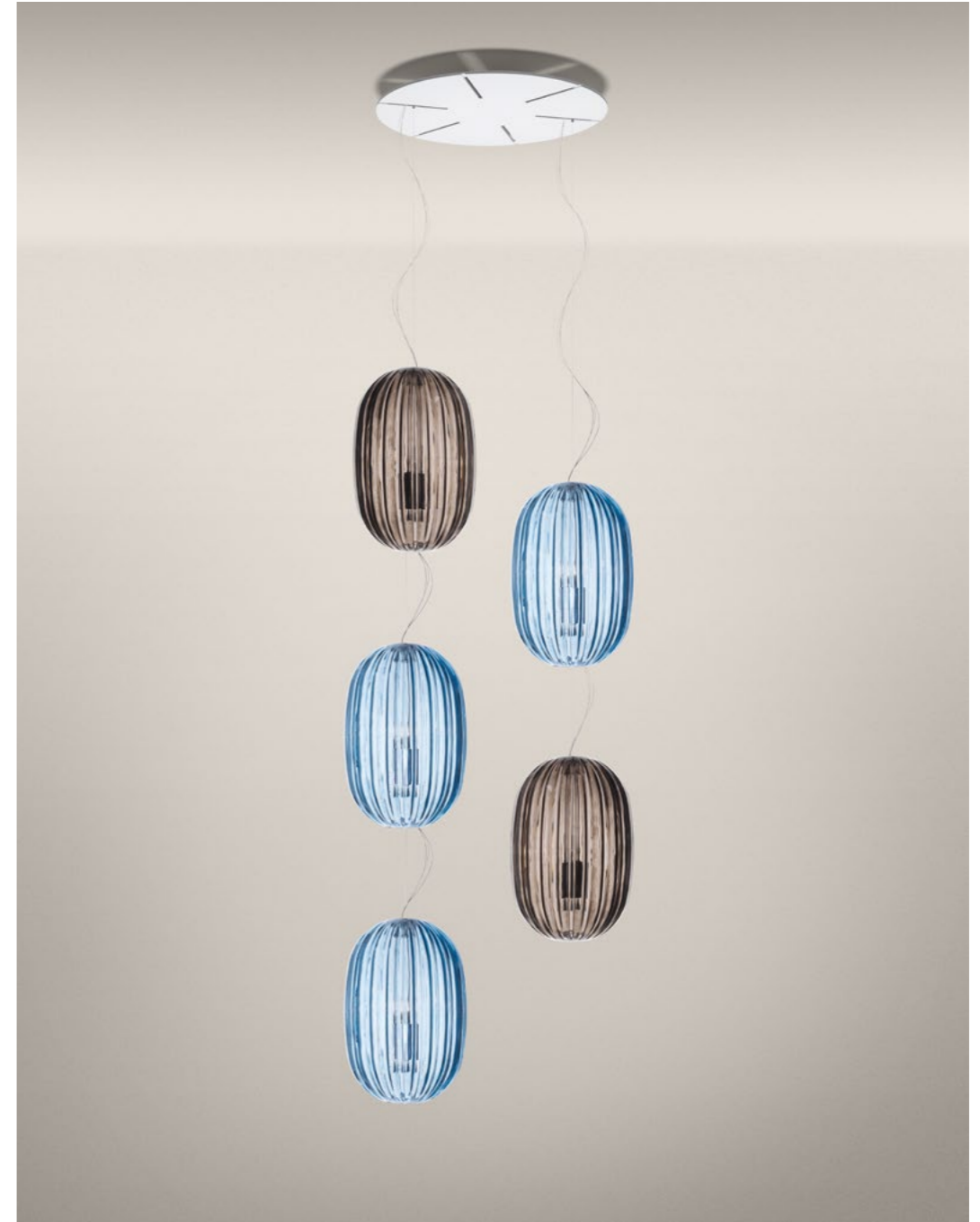
Gem



Aplomb / Aplomb mini



Tress media



Plass media

Kit decentramento
/ Decentralization kit



Kit B

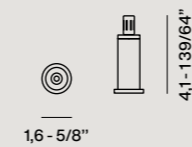
Kit decentramento / Decentralization kit

Accessories

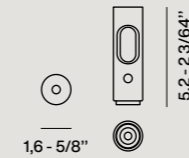
Con i kit di decentramento è possibile posizionare a piacimento le lampade a sospensione, indipendentemente dalla collocazione della fonte di alimentazione. Dal design estremamente discreto, per ridurre al minimo l'impatto visivo, viene proposto sia per modelli a cavo singolo autoportante che per quelli dotati di una o più funi in acciaio.

With the decentralization kits, it is possible to position suspension lamps at will, regardless of the location of the power source. With an extremely discreet design, to minimize the visual impact, it is proposed for both self-supporting single cable models and for those equipped with one or more steel cables.

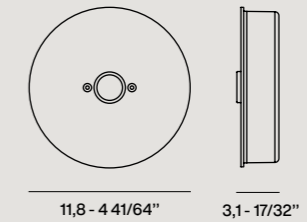
Kit B



Kit C



Kit M



Kit C



Kit M

Index — Ceiling lamps

274	Bahia / Bahia mini	288	Gem
276	Big Bang	290	Gregg
278	Caboche Plus	294	Lumiere XX
280	Chouchin	296	Rituals
284	Circus	300	Tartan
286	Folio	302	Twiggy

Asimmetrica composizione di forme. Una lampada da soffitto di grandi dimensioni che decora e illumina con la sua scenografica essenzialità e il suo magico gioco di ombre e bagliori. La versione mini mantiene l'impatto visivo e la raffinata eleganza del progetto originale, con dimensioni ridotte.

An asymmetrical composition of forms. A large ceiling lamp that decorates and illuminates with its theatrical essence and magical play of shadows and radiance. The mini version conserves the visual impact and refined elegance of the original design in a smaller size.

Bahia

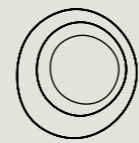


10 - 3 7/8"

Bahia mini



6,5 - 2 1/2"



76 - 27 1/2"

70 - 29 7/8"



55 - 20 7/8"

53 - 21 5/8"

Policarbonato stampato a iniezione.
Injection moulded polycarbonate.

Colori — Colors
Bianco. *White.*



Collection



p. 308

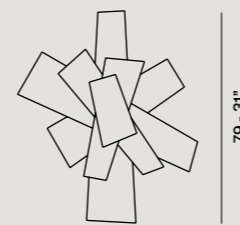
Discover more





Espllosiva creatività e dinamismo. Una sovrapposizione apparentemente caotica di piani in metacrilato traslucido crea una composizione di forte valore spaziale e carattere, che varia espressività in base alla scelta del colore. Offre un'illuminazione diffusa e riflessa a soffitto.

Explosive creativity and dynamism. An apparently chaotic overlay of translucent methacrylate panels generates a composition of great spatial value and character, which varies based on the choice of colour. The light is diffused and reflected on the ceiling.



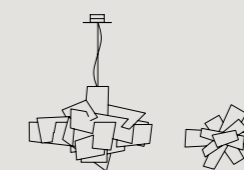
67 - 26 1/4"

Metacrilato e alluminio verniciato.
Methacrylate and varnished aluminium.

Colori — Colors
Bianco, rosso.
White, red.



Collection



p. 170

p. 310

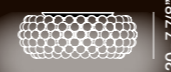
Discover more



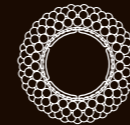


Trasparenza, leggerezza formale e una luce brillante. La riprogettazione degli archetti, del sistema di aggancio "a baionetta" e delle sfere che sembrano galleggiare nel vuoto una volta montate, garantiscono un effetto di trasparenza totale molto suggestivo. Illuminazione diretta verso il basso e diffusa di lato a soffitto.

Transparency, light shapes, and brilliant light. The redesign arches, the "twist lock" attachment system, and the spheres that appear to float in space once mounted, create a truly charming total transparency effect. Direct down light and diffused light towards the ceiling.



20 - 7 7/8"



50 - 19 1/2"

PMMA, policarbonato e metallo verniciato o cromato.
PMMA, polycarbonate and varnished or chromed metal.

Colori — Colors
Trasparente, grigio.
Transparent, grey.



Collection



p. 184



p. 316



p. 036



p. 102

Discover more

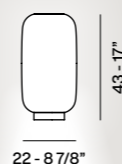




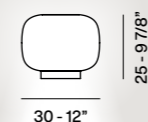
Rilettura in chiave design delle tradizionali lanterne giapponesi da cui prendono il nome. Modelli che sommano il fascino del vetro soffiato a una forma molto personale. Il colletto inferiore, colorato o bianco, completa il diffusore in modo originale.

A designer twist on traditional Japanese lanterns from which they take their name. Models that combine the charm of blown glass with a highly personal shape. A lower coloured or white rim completes the diffuser in an original way.

Chouchin 2
Reverse / Bianco



Chouchin 3
Reverse / Bianco

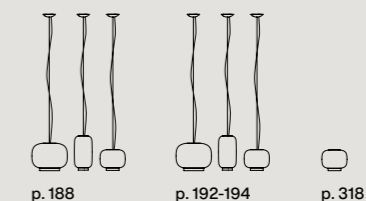


Vetro soffiato verniciato e ABS.
Varnished blown glass and ABS.

Colori — Colors
Reverse 2: bianco+verde.
Reverse 3: bianco+grigio.
*Reverse 2: white+green.
Reverse 3: white+grey.*
Bianco 2-3: bianco. *White.*



Collection



Discover more



Un morbido volume in vetro soffiato lucido sembra fissato da un bottone metallico satinato, posizionato in corrispondenza del foro centrale. Una forma sempre attuale che arreda con il suo segno semplice ed equilibrato, sottolineato dal bagliore intenso che filtra dal diffusore.

A soft volume in glossy blown glass fastened by a brushed metal button placed at the central opening. The form is always timely, to enhance spaces with a simple, balanced image, underscored by the intense, uniform brightness.

grande



13 - 5"

piccola



12 - 4 3/4"



46 - 18 1/8"



32 - 12 5/8"

Vetro soffiato, metallo verniciato o nichelato.
Blown glass, nickelplated or varnished metal.

Colori — Colors
Bianco. White.

Collection



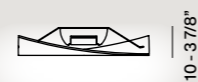
p. 320

Discover more



Un omaggio alla semplicità.
Un corpo visivamente leggero e delicato come un semplice foglio di carta, con due angoli piegati da un movimento appena accennato. Diffonde attraverso il suo schermo in vetro soffiato a bocca e satinato una luce calda e intensa.

A tribute to simplicity. A visually light, delicate form, like a simple sheet of paper with two corners slightly folded in a barely perceptible movement. Through its handcrafted and frosted blown glass screen it spreads warm, intense light.



10 - 3 7/8"



37,5 - 15"

48,5 - 18 7/8"

Vetro soffiato satinato e metallo verniciato.
Blown acid-etched glass and varnished metal.

Colori — Colors
Bianco. *White.*



Collection



p. 328

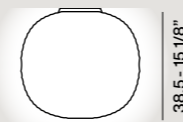
Discover more





Una vibrazione fluida sul vetro soffiato a bocca. La particolare lavorazione artistica del vetro di Gem conferisce straordinaria tridimensionalità al diffusore, che richiama le sfaccettature di un gioiello. Un effetto visivo sorprendente, a lampada spenta e accesa.

A fluid vibration on glass. The special artistic workmanship of the glass of Gem generates extraordinary three-dimensional appeal for the diffuser, featuring a graphic pattern that recalls the facets of a gem. A surprising visual effect, both when the lamp is on and off.



38,5 - 15 1/8"

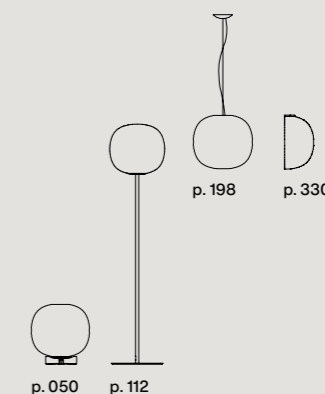
43 - 16 7/8"

Vetro incamiciato soffiato a bocca, in rilievo e acidato e ABS.
Hand-blown cased acidetched glass with reliefs and ABS.

Colori — Colors
 Bianco. *White.*



Collection



Discover more



Gregg

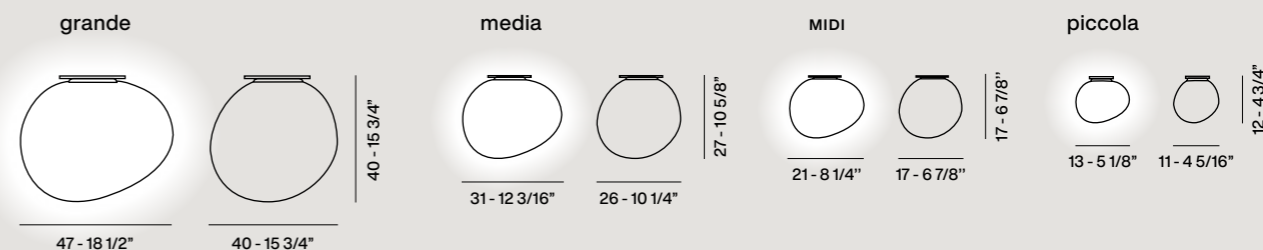
Ceiling





In vetro soffiato a bocca e satinato, ha una forma morbida e dinamica, che ricorda dei ciottoli levigati dall'acqua. Un volume puro e familiare nella sua facilità di lettura, eppure sorprendente per la forma asimmetrica. Diffonde una calda e morbida luminosità nell'ambiente.

In frosted blown glass, the lamp has a soft, dynamic form that suggests pebbles smoothed by water. A pure, familiar volume, of immediate visual clarity, yet surprising due to its asymmetrical form. For warm, relaxing ambient lighting.

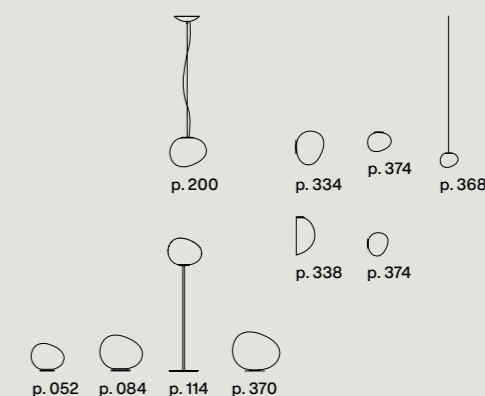


Vetro soffiato acidato, ABS o metallo verniciato.
Blown acid-etched glass, ABS or varnished metal.

Colori — Colors
Bianco. White.



Collection



Discover more



Caratterizzata dal taglio obliquo che seziona il diffusore in vetro soffiato in modo sorprendente ed originale: geometrie essenziali ed inedite realizzate con sapienza artigianale dai maestri vetrai. Utilizzando le due misure o orientando il vetro in maniera diversa, è possibile creare un gioco di vivaci composizioni a soffitto.

Featuring an oblique cut that slices the blown glass diffuser in a surprising, original way: essential geometric lines shaped by the extraordinary skill of master glassmakers. Using the two sizes or adjusting the glass in different ways, it is possible to create lively compositions on the ceiling.

Lumiere XXL



14 - 5 1/2"



34 - 13 1/2"

Lumiere XXS



10 - 4 1/8"



24 - 9 3/8"

Vetro soffiato e metallo verniciato.
Blown glass and varnished metal.

Colori — Colors
Bianco, grigio freddo.
White, cool grey.



Collection

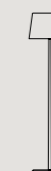
Discover more



p. 060-062-068



p. 072



p. 118



p. 346

Rituals

Ceiling





Traducono la magia luminosa delle lanterne di carta di riso orientali in forme di design contemporaneo, realizzate in un prezioso vetro soffiato a bocca arricchito da sottili incisioni, frutto di un sapiente lavoro artigiano. Le linee orizzontali sono al contempo decoro e filtrano la luce, che si diffonde calda e soffice.

The luminous magic of oriental rice paper lanterns, translated into contemporary design made with precious handcrafted blown glass enhanced by slender incisions, made with a refined technique. The horizontal lines are decorative, but also serve to spread warm, subtle radiance.

Rituals 1



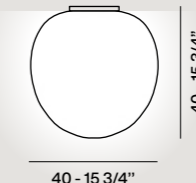
Rituals 2



Rituals 3



Rituals XL



Vetro soffiato satinato inciso e metallo verniciato.
Blown engraved satin glass and coated metal.

Colori — Colors
Bianco. White.



Collection



p. 220



p. 086



p. 130



p. 350



p. 348

Discover more





Vetro soffiato ricco di personalità, ottenuto con una particolare tecnica di soffiatura a bocca, che ricrea l'effetto del famoso tessuto scozzese. Caratterizzata da linee e pieghe che ne percorrono la superficie, generando un gioco grafico di luci e ombre. Illuminazione diretta verso il basso e soffusa nell'ambiente.

Blown glass with a vivid personality, crafted by hand with a particular technique to recreate the effect of the famous Scottish fabric. The lines and folds running across the surface generate the graphic interplay of lights and shadows. Direct downward lighting combined with soft ambient glow.



40 - 15 3/4"

Vetro soffiato in rilievo e acidato, ABS.
Blown acid-etched glass with reliefs, ABS.

Colori — *Colors*
Bianco. *White.*



Collection



p. 238

Discover more





Un segno arcuato sottile e flessibile, un ampio ed essenziale paralume: due temi di design che richiamano la versione da terra dell'icona Twiggy, trasferiti a soffitto. Massima flessibilità nel decentrare il punto luce: il braccio può rotare a 330°. Illuminazione diretta dell'area sottostante e riflessa verso l'alto.

A slender, flexible arc, an ample and essential shade: two design themes taken from the floor version of the iconic Twiggy, shifted to the ceiling. The lamp offers maximum flexibility of positioning: the arm can rotate 330°. For direct lighting of the zone below the unit, and ambient light reflected on the ceiling.

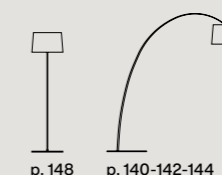


Materiale composito su base di fibra di vetro verniciato, policarbonato, PMMA e metallo verniciato.
Coated fibreglass based composite material, PMMA, polycarbonate and varnished metal.

Colori — Colors
Bianco, nero.
White, black.



Collection



Discover more



Index — Wall lamps

306	Aplomb	334	Gregg
308	Bahia / Bahia mini	336	Gregg Mirror
310	Big Bang	338	Gregg Semi
312	Birdie	340	Havana
314	Bit	342	Lake
316	Caboche Plus	344	Le Soleil
318	Chouchin Semi	346	Lumiere XX
320	Circus	348	Rituals
322	Double	350	Rituals Semi
324	Fields	352	Satellight
326	Filo	354	Tobia
328	Folio	356	Tress
330	Gem Semi	358	Tutù
332	Gioia		



Realizzata con uno speciale amalgama di cemento, piacevole alla vista e al tatto. Con il suo andamento obliquo dialoga con la parete di appoggio e permette un'ampia diffusione della luce, che viene liberata verso l'alto dall'apertura superiore e verso il basso da quella inferiore più piccola, determinando un raffinato gioco di luce a parete.

Made with a special concrete mix, pleasing to the eye and the touch. With its oblique shape it establishes a dialogue with the wall, emitting abundant light that is released upward by the large opening, and downward through a smaller one, to generate the refined play of light over the surface.



30 - 11 3/4"



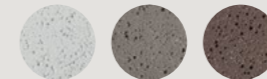
14 - 5 3/8"



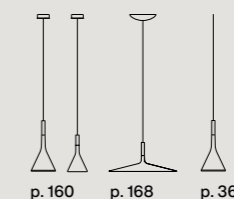
23 - 8 7/8"

Cemento colato a mano, metallo verniciato e alluminio.
Hand pouring concrete, varnished meta and aluminium.

Colori — Colors
Bianco, grigio cemento, marrone.
White, concrete grey, brown.



Collection



p. 160

p. 168

p. 362

Discover more

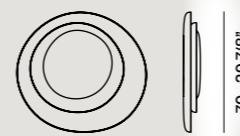


Un'armonia di luci e ombre arreda lo spazio con le sue ampie dimensioni e un design morbido e solare. Offre una sensazionale profondità visiva, grazie ai bagliori concentrici che si riflettono sulla parete e si diffondono nello spazio circostante. Compatta ed essenziale, la versione mini mantiene la seducente personalità della più grande, a cui può essere abbinata per creare scenografiche composizioni.

Harmony of lights and shadows to enhance any space, with large proportions and a soft, appealing design. The lamp offers sensational visual depth, thanks to the concentric glows reflected on the wall and spread into the surrounding space. Compact and essential, the mini version conserves the seductive personality of the larger model, with which it can be combined to create striking compositions.



Bahia



76 - 27 1/2" 10 - 3 7/8"

Bahia mini



55 - 20 7/8" 6,5 - 2 1/2"

Policarbonato stampato a iniezione.
Injection moulded polycarbonate.

Colori — Colors
Bianco. *White.*



Collection



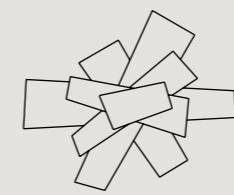
p. 274

Discover more



Un'esplosione di piani e ombre incrociate, da cui si genera un'illuminazione diffusa e riflessa allo stesso tempo. Corpo luminoso di forte valore spaziale, è ideale per personalizzare ambienti di vari stili. Varia espressività in base alla scelta del colore.

An explosion of criss-crossed planes and shadows, generating light that is diffused and reflected at the same time. A luminous presence of great spatial impact, ideal to personalize decors in a range of different styles. The choice of colour sets the tone.



79 - 31"

67 - 26 1/4"



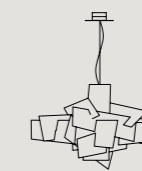
22 - 8 3/4"

Metacrilato e alluminio verniciato.
Methacrylate and varnished aluminium.

Colori — Colors
Bianco, rosso.
White, red.



Collection



p. 170



p. 276

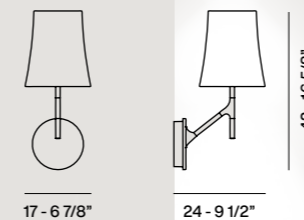
Discover more





Interpreta in chiave design la classica forma delle lampade con paralume. La versione a parete è una presenza amichevole che coniuga segno leggero e familiare a un carattere deciso. Il sostegno sottile richiama il disegno di un ramoscello, pronto ad accogliere un uccellino, "birdie" in inglese.

A design interpretation of the classic lamp with shade. The wall version is a friendly presence, combining a light, familiar image with a forceful character. The slender support suggests the form of a branch, ready to welcome a "birdie".

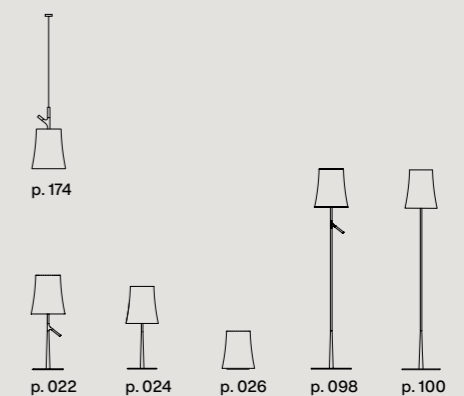


Policarbonato, acciaio e metallo verniciato.
Polycarbonate, varnished steel and metal.

Colori — Colors
Bianco, grigio.
White, grey.

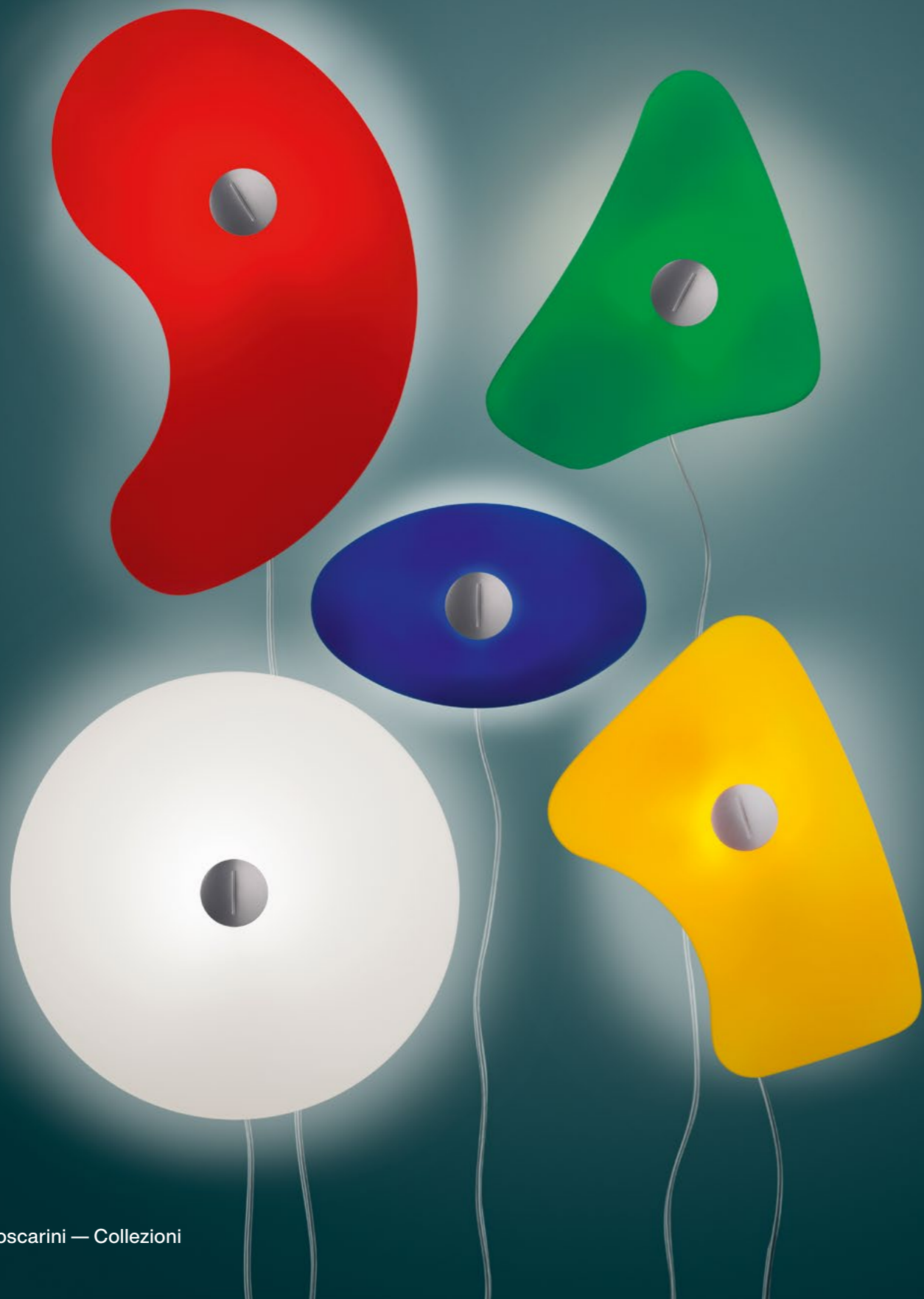


Collection



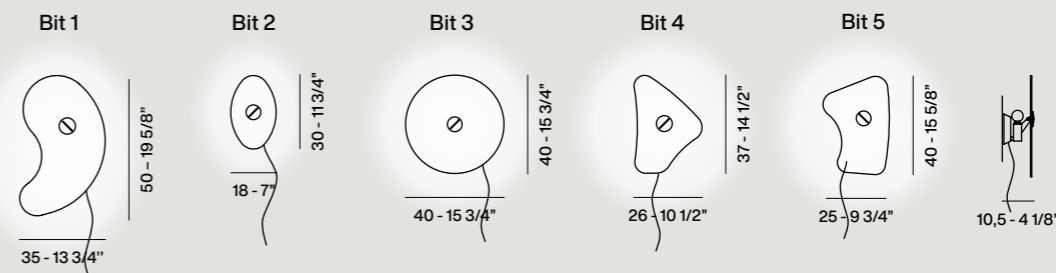
Discover more





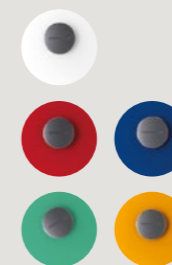
Un alfabeto di forme organiche e colori di base, con i quali creare infinite composizioni, inventando progetti e linguaggi. Diffusori in vetro verniciato colorato o bianco satinato in 5 forme irregolari e colori diversi, per un effetto di grande impatto grafico. Da spente richiamano un dipinto surrealista, da accese il gioco della luce delle vetrate a mosaico.

An alphabet of organic forms and basic colours with which to create infinite compositions, inventing projects and languages. The diffusers are in coloured or white coated glass with 5 irregular shapes in different hues, for an effect of striking graphic impact. When not in use the parts suggest a surrealist painting; when the lights are on, they generate a luminous mosaic effect.



Vetro serigrafato e metallo verniciato.
Silkscreen-printed glass and varnished metal.

Colori — Colors
Bianco, colorato (1 rosso, 2 blu, 4 verde, 5 arancio).
White, colored (1 red, 2 blue, 4 green, 5 orange).



Collection



p. 126

Discover more

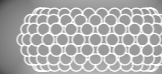




Un gioiello di design incastonato nell'architettura: un cuore caldo e luminoso, avvolto da uno scintillare di perle trasparenti. La riprogettazione degli archetti, del sistema di aggancio "a baionetta" e delle sfere che sembrano galleggiare nel vuoto una volta montate, garantiscono un effetto di trasparenza totale molto suggestivo. La luce radente a parete impreziosisce ogni ambiente con il suo straordinario effetto illuminante, nel quale ogni sfera riflette l'immagine della sorgente luminosa.

A design gem set in architecture: a warm, luminous heart, enveloped by sparkling transparent spheres. The redesign arches, the "twist lock" attachment system, and the spheres that appear to float in space once mounted, create a truly charming total transparency effect. It embellishes any space with its exceptional lighting, where each sphere mirrors the image of the light source.

media



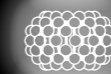
48 - 18 7/8"



24 - 9 1/2"

19,6 - 7 3/4"

piccola



31 - 12"



17,5 - 6 7/8"

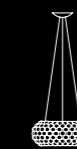
19 - 7 1/2"

PMMA, policarbonato e metallo verniciato o cromato.
PMMA, polycarbonate and varnished or chromed metal.

Colori — Colors
Trasparente, grigio.
Transparent, grey.



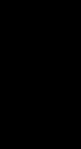
Collection



p. 184



p. 036



p. 102



p. 278

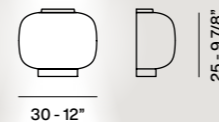
Discover more



Forma personale, sobria, in vetro soffiato lucido, che illumina senza abbagliare, diffondendo una calda e morbida luminosità. La chiusura del vetro a colletto proietta un triangolo di luce più intenso verso il basso. Disponibile con attacco a muro verniciato bianco, oro o grafite.

A personal, discreet form in shiny blown glass, for a glare-free, warm and gentle glow. The rim closing the glass projects a triangle of more intense light downward. Available with wall attachment in white, gold or graphite coated.

Chouchin Semi 3
Reverse / Bianco

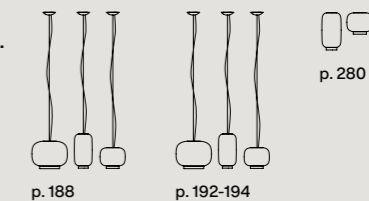


Vetro soffiato e metallo verniciato.
Blown glass and varnished metal.

Colori — Colors
Vetro: bianco.
Montatura: bianco, oro, grafite.
*Glass: white.
Frame: white, gold, graphite.*



Collection



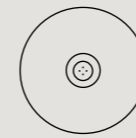
Discover more



Un volume morbido in vetro soffiato lucido che illumina senza abbagliare, un bottone di metallo che lo caratterizza e decora, posizionato in corrispondenza del foro centrale. Una forma sempre attuale che arreda con il suo segno semplice ed equilibrato.

A soft volume in shiny blown glass, for glare-free lighting. A metal button adds character and charm, positioned at the central opening. A form that is always timely, a decorative touch provided by a simple, balanced image.

grande



46 - 18 1/8"



13 - 5 1/8"

piccola



32 - 12 5/8"



12 - 4 3/4"

Vetro soffiato, metallo verniciato o nichelato.
Blown glass, nickelplated or varnished metal.

Colori — Colors
Bianco. *White.*



Collection



p. 284

Discover more



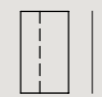


Un sinuoso volume in vetro soffiato, una linea chiusa che avvolge due fonti luminose e compie una curva verso la parete nello spazio che le separa. Il movimento del diffusore viene sottolineato dalla superficie lucida, in un gioco di eleganti riflessi. Diffonde un'illuminazione intensa e proietta sulla parete un fascio luminoso verso l'alto e verso il basso.

A flexuous volume in blown glass, a closed line that wraps the two light sources and forms a curve towards the wall across the separating space. The movement of the diffuser is emphasized by its glossy surface, in an elegant game of reflections. For intense light that projects beams upward and downward on the wall.



26 - 10 1/4"



13 - 5 1/8"

24 - 9 1/2"

Vetro soffiato e metallo verniciato.
Blown glass and varnished metal.

Colori — Colors
Bianco. *White.*

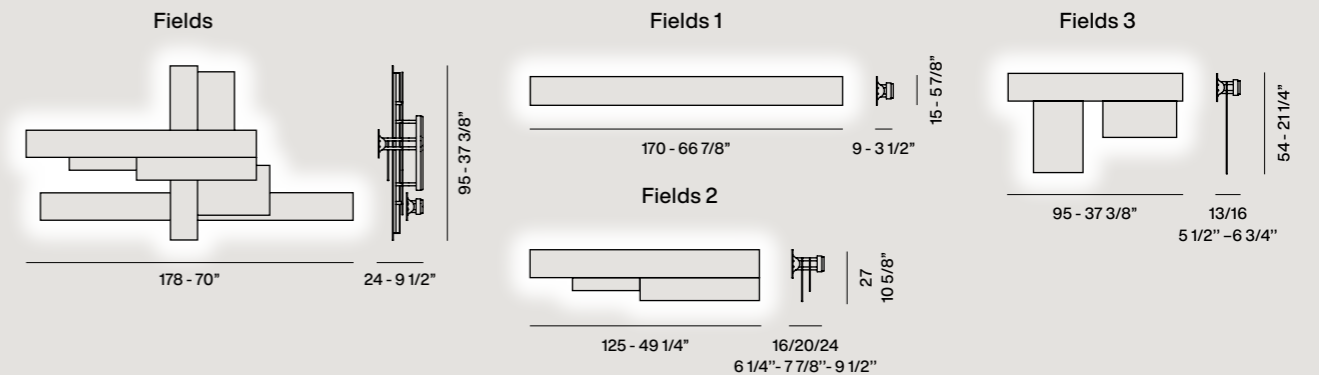


Discover more



Un progetto modulare.
Tre diversi elementi da utilizzare singolarmente o in molteplici combinazioni, per creare le più diverse geometrie luminose. Fields 1 ha un design lineare, mentre Fields 2 e Fields 3 sovrappongono diverse superfici creando un effetto tridimensionale. Tutti i modelli possono essere posizionati orizzontalmente o verticalmente.

A modular design. Three different parts, to use individually or in multiple combinations, creating a wide range of geometric effects. Fields 1 is linear, while Fields 2 and Fields 3 overlap different surfaces to create a three-dimensional effect. All the models can be positioned horizontally or vertically.



Metacrilato, alluminio verniciato e policarbonato.
Methacrylate, varnished aluminium and polycarbonate.

Colori — Colors
Bianco, arancio.
White, orange.



Anche uso in verticale.
Horizontal and vertical use.

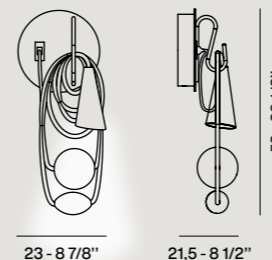
Discover more





Fra scultura luminosa e opera di design, è composta da parti diverse e definite, che creano un insieme assolutamente unico. Con una fortissima carica arredativa, è un abaco di colori che ne evidenziano la molteplice identità. Frutto del pensiero di un autore che scompone e poi ricomponne la lampada nelle sue singole componenti.

Between a luminous sculpture and a work of design, the lamp is composed of different, specific parts that create an absolutely unique whole. For exceptional decorative impact, it comes in a range of colours, as in a case of multiple identities. The result of creative thinking that breaks down and reassembles the lamp in its single components.



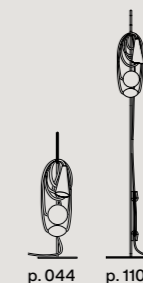
Porcellana, cavo tessile, vetro soffiato e metallo verniciato.
Porcelain, textile cable, blown glass and varnished metal.

Versioni disponibili
— Available versions:
Amethyst Queen, Emerald King, Teodora, Eastern Coral.

Le versioni disponibili sono quelle illustrate a pag. 045.
The available versions are those shown at page 045.

Collection

Discover more

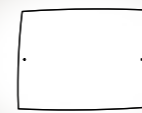




Rilegge un materiale tradizionale come il vetro soffiato a bocca e satinato, alla luce della cultura contemporanea del design. Un corpo visivamente leggero e delicato come un semplice foglio di carta con due angoli piegati da un movimento appena accennato. Diffonde una luce calda e intensa.

A reinterpretation of a traditional material like blown, frosted glass, seen in the light of contemporary design culture. A visually light body, delicate like a single sheet of paper with two corners slightly folded, the lamp emits warm, intense glow.

grande



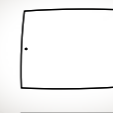
48,5 - 18 7/8"



10 - 3 7/8"

37,5 - 15"

piccola



33 - 13"



8 - 3 1/8"

25 - 9 5/6"

Vetro soffiato satinato e metallo verniciato.
Blown acid-etched glass and varnished metal.

Colori — Colors
Bianco. *White.*



Collection



p. 286

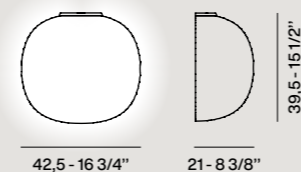
Discover more





Dichiara a prima vista la preziosità del materiale: ha un pattern grafico caratterizzato da onde che si rincorrono sulla sua superficie e rendono la lampada inconfondibile anche da spenta. Le sfaccettature tridimensionali sono ottenute con la tecnica artigianale della soffiatura a bocca del vetro in uno stampo con incisioni. Supporto in tre diversi colori con finitura opaca.

The precious beauty of the material is conveyed at first glance. The graphic pattern of waves on the surface makes the lamp a vivid presence, even when not in use. The three-dimensional facets are made with a technique of glassblowing inside a mould with incisions. The support is in three different colours, with a matte finish.

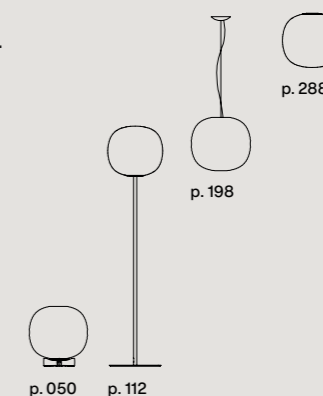


Vetro soffiato in rilievo acidato e metallo verniciato.
Blown acid-etched glass with reliefs and varnished metal.

Colori — Colors
Vetro: bianco.
Montatura: bianco, oro, grafite.
*Glass: white.
Frame: white, gold, graphite.*



Collection



Discover more





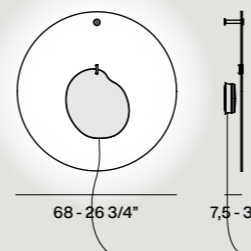
Gioia, design Andrea Anastasio, 2019

Wall

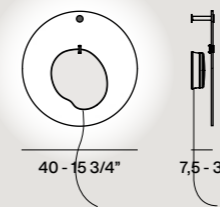
Un gioiello pensato per adornare lo spazio domestico. La magia sta nella composizione: un elemento in marmo statuario collocato al centro di un disco in polimetilmetacrilato trasparente. A unire i due materiali, un unico anello impreziosito da una lavorazione artigianale; l'insieme è fissato a parete da un piccolo perno. I due elementi, liberi di muoversi, ricordano il ritmo oscillante di un orecchino.

A jewel to adorn domestic space. The magic lies in the separation of the parts: a shape in statuary marble placed at the centre of a disk of transparent polymethylmethacrylate. The two materials are joined by a single ring, enhanced by fine craftsmanship. The composition is attached to the wall by a small pin. The two parts, free to move, suggest the wavering rhythm of an earring.

Gioia grande



Gioia



PMMA, marmo, policarbonato, ottone lucido e alluminio verniciato.
PMMA, marble, polycarbonate, polished brass and coated aluminium.

Colori — Colors
Azzurro, rosa, verde.
Light blue, pink, green.



Discover more

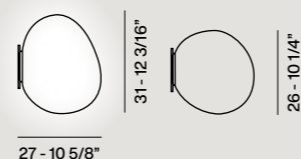




Forme organiche che ricordano ciottoli levigati dall'acqua realizzate in vetro soffiato a bocca. Disponibile in tre misure, è perfetta anche per creare composizioni multiple a parete. Supporto in tre diversi colori per coordinare molteplici esigenze di arredo. Diffondono una calda e morbida luminosità.

Organic forms that suggest stones shaped by water, made of blown glass. Available in three sizes, also perfect to create multiple compositions on the wall. The support is in three different colours for coordination with various decor settings. For warm, soft lighting.

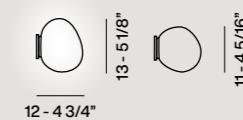
media



MIDI



piccola

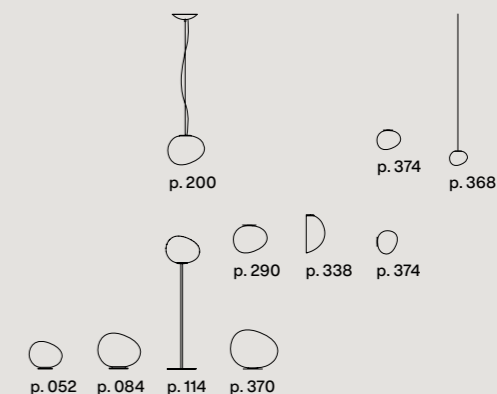


Vetro soffiato acidato e ABS.
Blown acid-etched glass and ABS.

Colori — Colors
Bianco. White.



Collection



Discover more

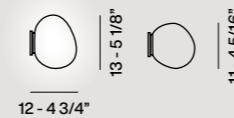




Realizzata in vetro soffiato satinato, ha una forma morbida, amichevole e dinamica, con una forma che ricorda un ciottolo levigato dall'acqua. Grazie ad un sistema di ghiera può essere installata integrata nello specchio tramite la creazione di un foro. La forma completamente chiusa la rende perfetta per un uso come lampada "da trucco".

Made of satin finish blown glass, it has a soft, friendly, and dynamic shape, which recalls that of pebbles smoothed by water. Thanks to a special system of ring nuts, it can be installed integrated into the mirror itself by making a hole. The completely closed shape makes it perfect for use as a "make-up" lamp.

piccola

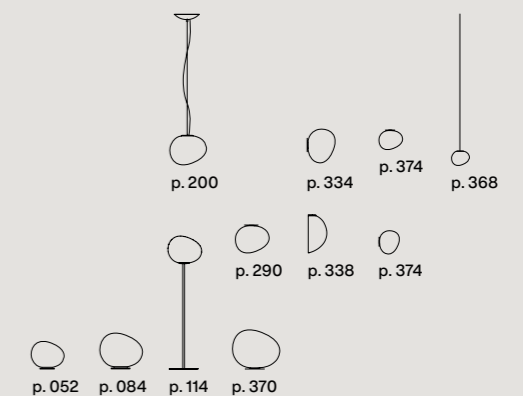


Vetro soffiato acidato e metallo verniciato.
Blown acid-etched glass and white lacquered metal.

Colori — Colors
Vetro: bianco.
Montatura: bianco.
*Glass: white.
Frame: white.*



Collection



Discover more

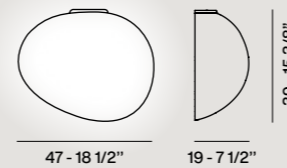




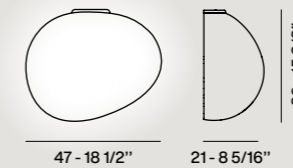
Seziona a metà il vetro di Gregg, forma organica e asimmetrica che non fa riferimento alla geometria pura, ma ricorda ispirazioni naturali. Un volume di facile lettura, eppure sorprendente, in cui il vetro abbraccia completamente la fonte luminosa, disponibile con due diversi orientamenti. Supporto in tre colori.

Cutting halfway across Gregg's glass, the lamp has an organic, asymmetrical form, not based on pure geometry but on natural inspirations. A volume that is easy to recognize yet always surprising, in which the glass completely wraps the light source, available in two different directional options. The support comes in three colours.

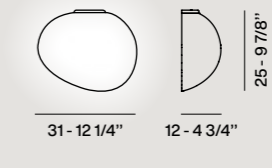
Gregg Semi 1 grande



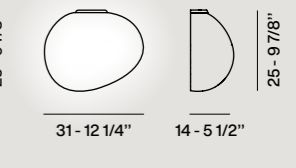
Gregg Semi 2 grande



Gregg Semi 1 media



Gregg Semi 2 media

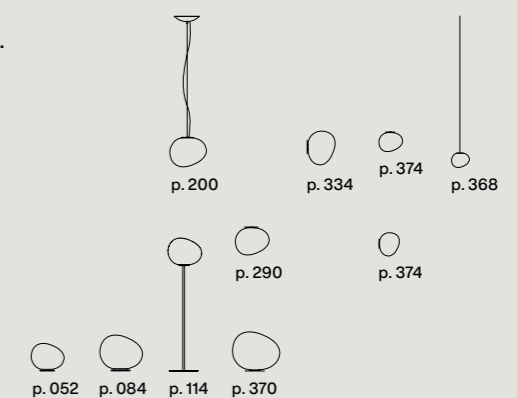


Vetro soffiato satinato e metallo verniciato.
Blown acid-etched glass and white lacquered metal.

Colori — Colors
Vetro: bianco.
Montatura: bianco, oro, grafite.
*Glass: white.
Frame: white, gold, graphite.*



Collection



Discover more



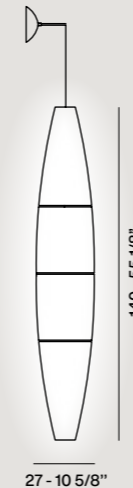


Havana, design Jozeph Forakis, 1993

Wall

Affusolata come un sigaro, ha uno stile senza età e si trova a proprio agio in qualsiasi ambiente, diffondendo attorno a sé una luminosità calda e soffusa che caratterizza ulteriormente il famoso e inimitabile design. Gli spazi vuoti tra i quattro segmenti del diffusore si riempiono di luce quando è accesa.

Tapered like a cigar, this product has a timeless style to fit perfectly into any setting, spreading warm, soft light that adds further character to this famous, inimitable design. The gaps between the four segments of the diffuser are filled with light when the unit is on.

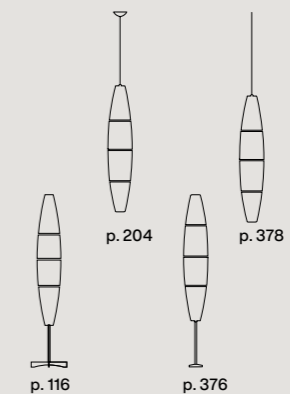


Polietilene stampato a iniezione e metallo verniciato.
Injection moulded polyethylene and varnished metal.

Colori — *Colors*
Bianco. *White.*



Collection



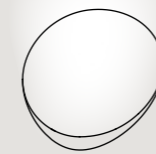
Discover more



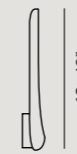


Una luce liquida e sorprendente sorge dall'interno della piega collocata lungo il bordo esterno e scorre verso l'interno, sulla sua superficie lucida e asimmetrica. Una forma organica, ricca di colore, per dare movimento e creare originali giochi di luce anche su pareti di grandi dimensioni.

Liquid, surprising light springs from inside the fold placed along the outer border and flows inside on the glossy asymmetrical surface. An organic form enhanced by colour to grant movement and to create original games of light on large walls.



48,5 - 19 1/8"



9,5 - 3 3/4"

ABS stampato a iniezione
verniciato e alluminio.
*Varnished injection moulded
ABS and aluminium.*

Colori — Colors
Avorio, rosso.
Ivory, red.



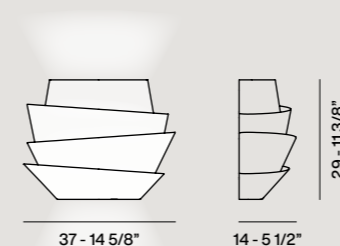
Discover more





Forte presenza scenica con una profondità ridotta. Composta da fasce sovrapposte, dinamicamente irregolari, che fungono da elementi riflettenti verso l'interno e da diffusori verso l'esterno, creando un effetto caldo e solare, grafico e luminoso allo stesso tempo.

A forceful theatrical presence, of minimal depth. Composed of overlapping, dynamically irregular bands that reflect light inward and spread it outward, creating a warm effect of sunny brightness and graphic impact.



Policarbonato stampato a iniezione e verniciato e metallo verniciato.
Injection moulded coated polycarbonate and varnished metal.

Colori — *Colors*
Bianco. *White.*



Collection



p. 206

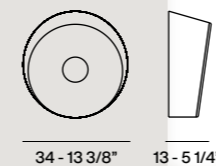
Discover more



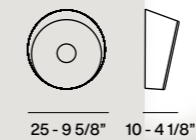
Contraddistingue lo spazio con il proprio dinamismo. Caratterizzata dal taglio obliquo che seziona il diffusore in vetro soffiato in modo sorprendente: geometrie inedite realizzate con sapienza artigianale dai maestri vetrai. Utilizzando le due misure o orientando il vetro in maniera diversa, è possibile creare un gioco di eleganti composizioni.

Dynamism in space. The oblique opening cuts across the blown glass diffuser in a surprising way, with unusual geometric lines skilfully created by master glassmakers. Using the two measurements and adjusting the glass in different ways, it is possible to create elegant compositions.

Lumiere XXL



Lumiere XXS



Vetro soffiato e metallo verniciato.
Blown glass and lacquered metal.

Colori — Colors
Bianco, grigio freddo.
White, cool grey.



Collection

Discover more



p. 060-062-068



p. 072



p. 118

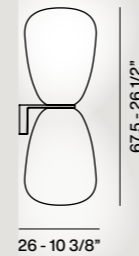


p. 294



Caratterizzate da una particolare lavorazione del vetro soffiato, con linee irregolari che ne incidono la superficie e creano un'illuminazione calda e vibrante. Simile al piedistallo di un'opera d'arte, il supporto a L della versione a parete permette diverse soluzioni: con il vetro posizionato verso l'alto o il basso, o in versione che monta due diffusori.

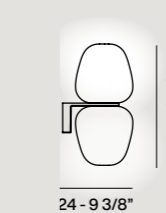
Featuring special workmanship on the blown glass, with irregular lines that etch the surface to generate warm, vibrant light. Like the pedestal of a work of art, the L-shaped support of the wall version permits different solutions: the glass can be positioned upward or downward, or in a version that combines two diffusers.

Rituals 1
doppia double

Rituals 1



Rituals 2

Rituals 3
doppia double

Rituals 3

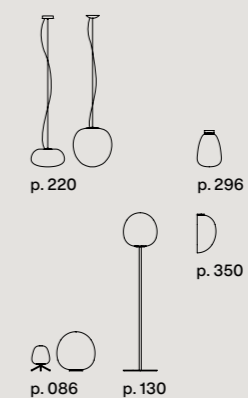


Vetro soffiato satinato inciso e metallo verniciato.
Blown engraved satin glass and varnished metal.

Colori — Colors
Bianco. White.



Collection



Discover more

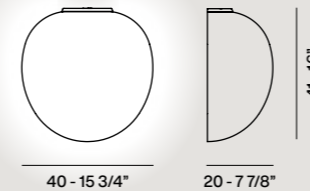




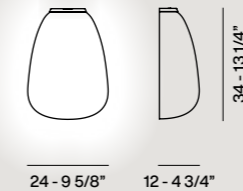
Parla il linguaggio della bellezza e della poesia. Un vetro soffiato a bocca arricchito da sottili incisioni, che ricordano il gesto della molatura, frutto di un sapiente lavoro artigiano. Un decoro morbido e affascinante, che contribuisce a filtrare l'intensità della sorgente, diffondendo una luce calda e soffice nell'ambiente.

A lamp that speaks the language of beauty and poetry. Handcrafted blown glass enhanced by slender incisions, as in the milling technique, with an effect of refined workmanship. A soft, fascinating decoration that contributes to soften the light's intensity, spreading a warm glow in the space.

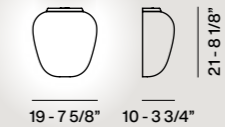
Rituals XL Semi



Rituals 1 Semi



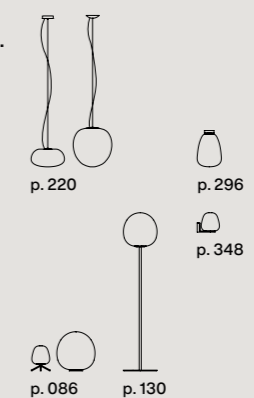
Rituals 3 Semi



Vetro soffiato satinato inciso e metallo verniciato.
Blown engraved satin glass and varnished metal.

Colori — Colors

Vetro: bianco.
Montatura: bianco, oro, grafite.
*Glass: white.
Frame: white, gold, graphite.*

**Collection**

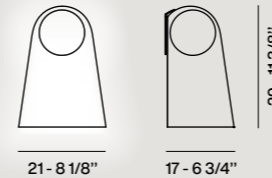
Discover more





Ha un effetto visivo simile a un drappo di vetro trasparente, con una morbida e sognante luminosità che si diffonde da un globo in vetro satinato. Un design poetico e sorprendente, completamente realizzato in vetro soffiato a bocca. Trasmette una luminosità calda, morbida e gentile che non abbaglia.

The visual effect is that of a curtain of transparent glass, with soft, dreamy luminosity that spreads from a globe in frosted glass. A poetic, surprising design, completely crafted by hand in blown glass. For warm, soft, gentle brightness without the slightest suggestion of glare.



Vetro cristallo soffiato a bocca, vetro incamiciato acidato e alluminio verniciato.
Hand-blown crystal glass, cased acid-etched glass and varnished aluminium.

Colori — *Colors*
Bianco e trasparente.
White and transparent.



Collection



p. 222



p. 092

Discover more

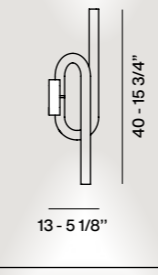
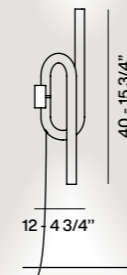


Esempio di come la semplicità possa avere carattere. Disponibile con alimentazione a parete o con cavo esterno bianco, emette luce verso l'alto e verso il basso dalle due estremità della lampada. Cinque diversi colori, pensati per sottolineare o mimetizzarne la presenza.

A prime example of how simplicity can have character. Available with wall power supply or with a white external cable, it casts light up and down from either end of the lamp. Five different colours, designed to emphasise or camouflage its presence.

con cavo
with cable

senza cavo
without cable



Metallo e alluminio verniciato a liquido o dorato.
Liquid varnished or gold painted metal and aluminum.

Colori — Colors
Bianco, nero, giallo fluo, arancione fluo, oro.
White, black, fluo yellow, fluo orange, gold.



Collection



p. 132

Discover more





Un nastro di fibra di vetro e resina intrecciato con ordinata casualità è la struttura e il decoro della lampada. Un effetto grafico e scenografico grazie alla luce che filtra attraverso l'intreccio di materiale composito e viene diffusa nell'ambiente e diretta verso l'alto.

A ribbon of glass and resin woven with orderly randomness forms the structure and decoration of the lamp. A graphic, theatrical presence, thanks to the light that filters through the composite material, diffused in space and directed upward.

grande



13,5 - 5 1/2"



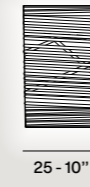
59 - 23 1/4"

25 - 10"

piccola



13,5 - 5 1/2"



40 - 15 3/4"

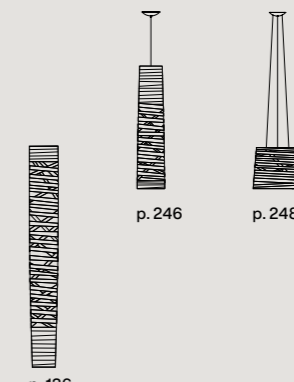
25 - 10"

Materiale composito su base di fibra di vetro verniciato, metallo verniciato.
Compound material on lacquered glass fibre base and varnished metal.

Colori — *Colors*
Bianco, nero.
White, black.



Collection



p. 136

p. 246

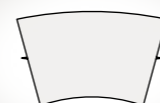
p. 248

Discover more



Come un leggiadro velo di vetro soffiato, può essere disposta verso l'alto o il basso, ottenendo due diversi effetti decorativi e di illuminazione. Libera sulla parete un fascio luminoso deciso verso l'alto e verso il basso e attraverso il diffusore proietta nell'ambiente una luce calda.

Like a graceful veil of blown glass, the unit can be aimed up or down, obtaining two different decorative and luminous effects. On the wall, it releases a forceful luminous beam, upward and downward, while emitting warm ambient lighting through the diffuser.



29 - 11 3/8"



13 - 5 1/8"

18 - 7 1/8"

Vetro soffiato, metallo e alluminio.
Blown glass, metal and aluminium.

Colori — Colors
Bianco. *White.*



Discover more



Index — Outdoor lamps

362	Aplomb	380	Solar
364	Cri Cri	382	Twiggy Grid <i>tavolo / Lettura</i>
368	Gregg <i>suspension</i>	384	Twiggy Grid <i>floor</i>
370	Gregg <i>floor</i>	388	Twiggy Grid <i>suspension</i>
374	Gregg <i>ceiling, wall</i>	390	Uto
376	Havana <i>floor</i>		
378	Havana <i>suspension</i>		

Eleganza, levità, pulizia formale con un cemento simile nell'aspetto all'amalgama del progetto originale, ma variato nella composizione per resistere alle intemperie. Proposta con un lungo cavo anche per essere avvolta, ad esempio, attorno a un pilone o a un ramo di un albero. Crea un'illuminazione puntuale e diretta.

Elegance, lightness and clean form made with concrete similar in its appearance to the mix of the original project, but varied in its composition to stand up to weathering. It is provided with a long cable also to be wrapped, for example, around a pole or a tree branch. For precise direct lighting.

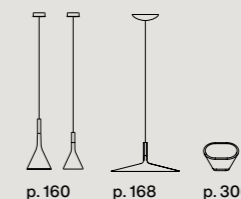


Cemento colato a mano e alluminio.
Hand pouring concrete and aluminium.

Colori — Colors
Rosso pompeiano, verde salvia, grigio chiaro.
Pompeian red, sage green, light grey.



Collection



Discover more



Cri Cri

Outdoor portable

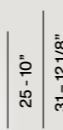


Una luce “easy” senza cavo, con batteria interna ricaricabile, da appendere o appoggiare dove si vuole, sia in esterno che in interno. Da sola o in combinazione, aperta o regolata a metà altezza, permette di creare diversi scenari luminosi. Intensità luminosa regolabile su tre diversi livelli con un semplice tocco. Quando non utilizzata si richiude su sé stessa per essere riposta con un ingombro minimo.

An “easy” cordless lamp with an internal rechargeable battery, to hang or place where desired, both indoors and outdoors. Alone or in a combination, open or regulated at half height, it allows you to create a variety of luminous settings. The brightness can be adjusted to three different levels with a simple touch. When not in use it can be closed, to occupy a minimum of storage space.



23,5 - 9 1/4"



25 - 10"

31 - 12 1/8"



5 - 1 7/8"

Silicone, ABS e PMMA.
Silicone, ABS and PMMA.

Colori — Colors
Verde, rosso.
Green, red.

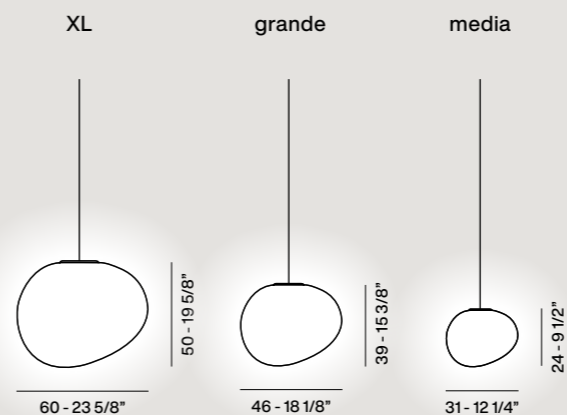


Discover more



Forme organiche e familiari pensate per creare presenze luminose e composizioni all'aria aperta. Cattura lo sguardo per il suo mutare aspetto a seconda del punto di vista: ci si gira attorno e la lampada appare sempre diversa. Materiale resistente agli urti e agli agenti atmosferici. Luminosità morbida.

Organic and familiar forms designed to create luminous presences and outdoor compositions. It catches the eye with the way its appearance changes, depending on the vantage point: walking around it, the lamp always looks different. The material stands up to impact and weathering. For soft light.



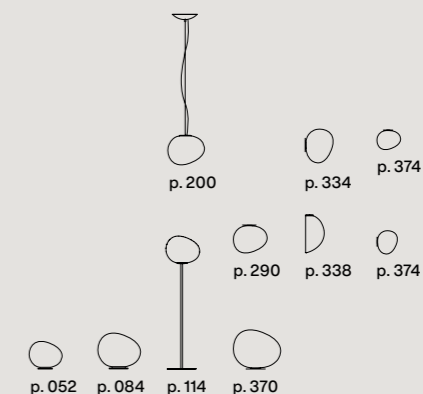
Polietilene stampato in rotazionale e metallo verniciato.
Rotational moulded polyethylene and varnished metal.

Colori — *Colors*
Bianco. *White.*



Collection

Discover more

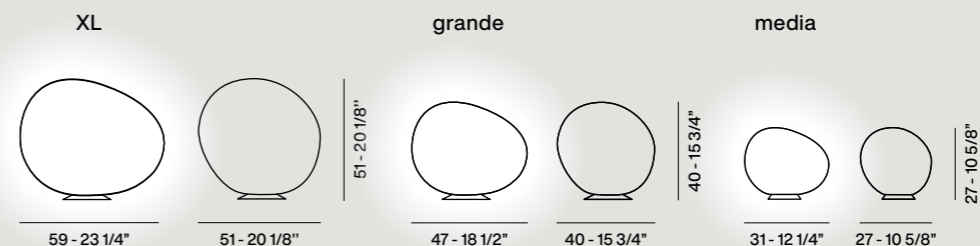






Molteplici le possibilità di utilizzo, duplice l'emozione: di giorno con una forma organica e pura, di notte con una calda luminosità. Decorazione e illuminazione allo stesso tempo, si presta a caratterizzare diverse situazioni: una terrazza, un giardino, un patio così come un ambiente living all'aperto.

Multiple usage options, and a dual impression: a pure, organic form in the daytime, a warm glowing presence at night. Simultaneously decorative and effective, it adapts to many different situations: a terrace, a garden, a patio, or an outdoor living area.

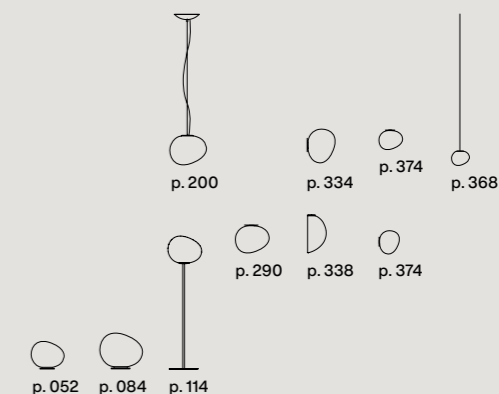


Polietilene stampato in rotazionale e metallo verniciato.
Rotational moulded polyethylene and varnished metal.

Colori — Colors
Bianco. *White.*

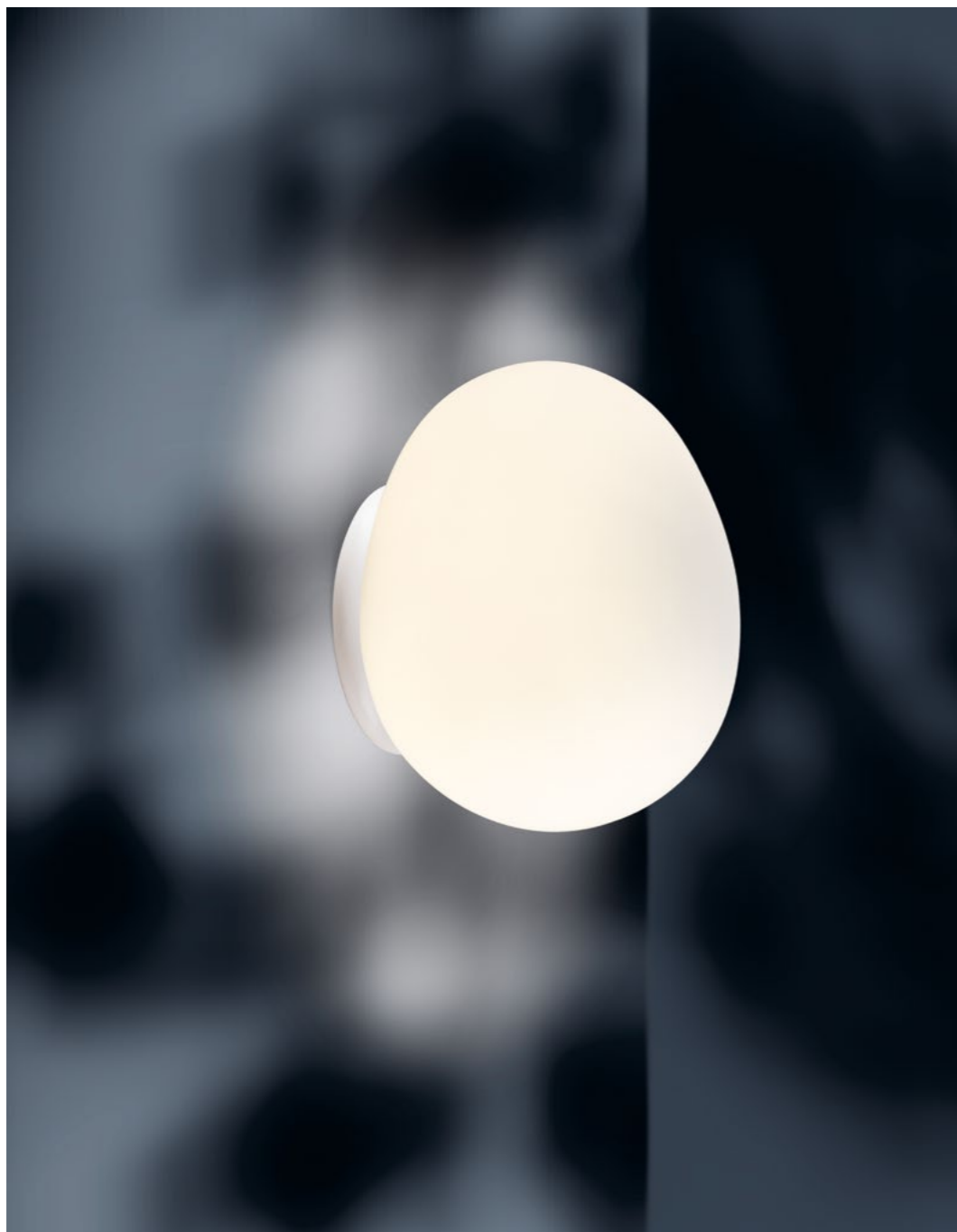


Collection



Discover more





In vetro soffiato a bocca può essere utilizzata da parete e a soffitto. La forma asimmetrica e organica ricorda forme naturali, come un ciottolo levigato dall'acqua o l'uovo di un animale mitologico. La sorgente a LED integrata garantisce ottima temperatura di colore, efficienza energetica e dimmerabilità.

In blown glass, for use on the wall or the ceiling. The asymmetrical organic form evokes nature, like a stone polished by water, or the egg of some mythical beast. The built-in LED source guarantees optimized colour temperature, energy efficiency and dimmable operation.

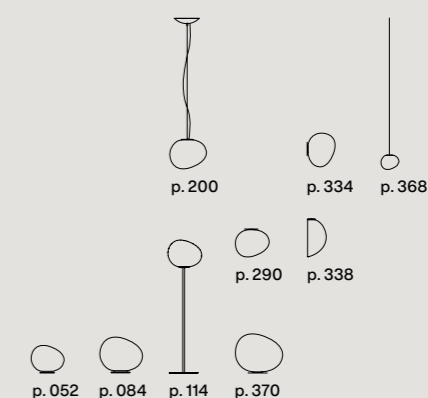


Vetro soffiato satinato e alluminio verniciato.
Blown acid-etched glass and coated aluminium.

Colori — Colors
Bianco. White.



Collection



Discover more



Versione da esterno di un bestseller, il suo diffusore è formato da un unico elemento in polietilene stampato. Le tre basi diverse ne permettono l'uso in diverse situazioni all'aperto. È ideale per illuminare gli spazi all'aria aperta, arricchendoli di una presenza che è in grado di integrarsi nell'ambiente. In gruppo crea scenografie di luce dall'aspetto quasi arboreo.

The outdoor version of a bestseller, with a diffuser formed by a single piece of moulded polyethylene. The three different bases allow it to be used in different outdoor situations. Ideal for outdoor spaces, it enhances them with a presence that fits perfectly into the setting. Arranged in a group, the lamp creates luminous scenarios with an almost arboreal character.

Havana Outdoor



173,5 - 68 1/4"

23 - 9 1/16"

Havana Outdoor
bassa

144 - 56 5/8"

23 - 9 1/16"

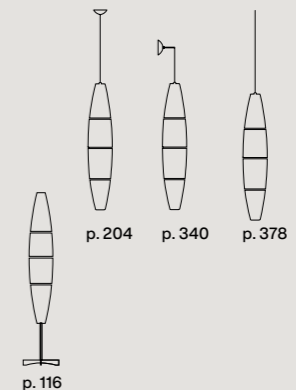
base
basecilindro
underground
basepicchetto
stake
mounted

Polietilene stampato in rotazionale e metallo verniciato.
Rotational moulded polyethylene and varnished metal.

Colori — *Colors*
Bianco. *White.*



Collection



Discover more





Segno giovane e leggero che ricorda la forma di un sigaro, da cui ironicamente prende il nome. È realizzata in un unico corpo in polietilene - materiale leggero, durevole e resistente - con segni che ricordano la suddivisione in segmenti che caratterizza il design del modello da interni.

A young, light image that suggests the form of a cigar, ironically echoed by its name. It is made with a single piece of polyethylene - a light, durable, strong material - with signs that reference the subdivision in segments of the indoor model.



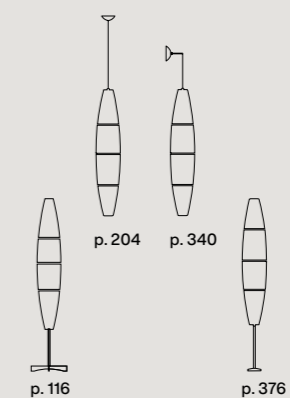
23 - 9 1/16"

Polietilene stampato in rotazionale e metallo verniciato.
Rotational moulded polyethylene and varnished metal.

Colori — *Colors*
Bianco. *White.*



Collection

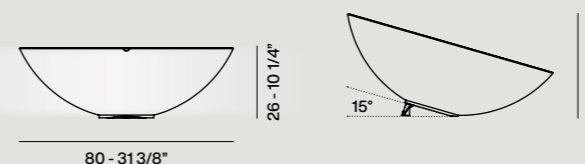


Discover more



Non solo una lampada, ma un focolare contemporaneo attorno al quale ritrovarsi e conversare all'aria aperta in sintonia con un concetto trasversale dell'abitare, nel quale il giardino può diventare un ambiente living. Il piano d'appoggio diventa un tavolino dove posare oggetti. Può essere inclinata in più posizioni, dando origine a differenti effetti, atmosfere e profondità di luce.

Not just a lamp, but a contemporary hearth around which to gather, conversing in the open air in tune with a versatile concept of dwelling, where the garden can become a true living room. The support becomes a table on which to place objects. It can be set at an angle, in multiple positions, giving rise to different effects, atmospheres and depths of light.



Polietilene stampato a rotazione, gres e metallo verniciato.
Rotational moulded polyethylene, porcelain stoneware top shelf and varnished metal.

Colori — Colors
Marrone. Brown.



Discover more

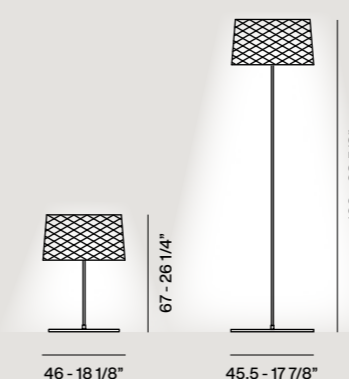


Un concetto formale di leggerezza declinato in una lampada da terra e da tavolo dallo stelo sottile e dal caratteristico diffusore intrecciato realizzato da fettucce di materiale composito. Perfetta per uso outdoor, è disponibile in due colori armonizzandosi con ambienti diversi.

A formal concept of lightness interpreted in a floor and table lamp with a slender stem and the characteristic woven shade made with ribbons of composite material. Perfect for outdoor use. Available in two colours, for coordination with different settings.

tavolo / table

Lettura



Materiale composito su base di fibra di vetro laccato, PMMA, metallo verniciato e alluminio. *Varnished fibreglass based composite material, PMMA, varnished metal and aluminium.*

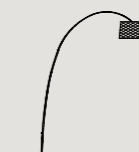
Colori — *Colors*
Carminio, greige.
Carmine, greige.



Collection



p. 388



p. 384

Discover more



Twiggy Grid

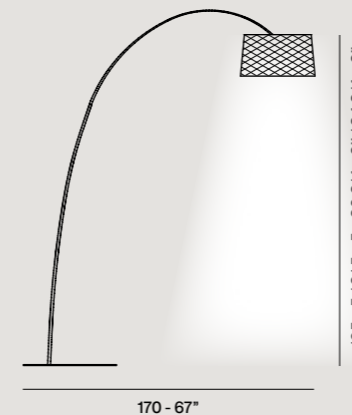
Outdoor floor





Una lampada-icona nella sua variante da esterno, in cui il progetto è stato completamente ripensato nella parte illuminotecnica e nell'estetica del diffusore, con una superficie a intreccio che ha valore sia funzionale che estetico: permette di schermare l'intensità della fonte luminosa e allo stesso tempo costruisce un dialogo con le forme circostanti.

An iconic lamp in its outdoor version, where the design has been completely revised in technical terms and in the image of the diffuser, with a woven surface that adds both functional and aesthetic value: it screens the intensity of the light source, while at the same time constructing a dialogue with surrounding forms.



Materiale composito su base di fibra di vetro laccato, PMMA, metallo verniciato e alluminio.
Varnished fibreglass based composite material, PMMA, varnished metal and aluminium.

Colori — *Colors*
Carminio, greige.
Carmine, greige.



Collection



p. 388



p. 382

Discover more





Ottima per i “territori di passaggio” tra un dentro e un fuori come i porticati. Versione da esterno della lampada-icona Twiggy. La superficie a intreccio ha valore sia funzionale che estetico: permette di schermare l'intensità della fonte luminosa e allo stesso tempo costruisce un dialogo con le forme circostanti.

Excellent for “territories of transit” between an interior and an outdoor space such as a porch. The outdoor version of the iconic Twiggy lamp has a woven surface with both functional and image value: it screens the intensity of the light source, while at the same time constructing a dialogue with surrounding forms.



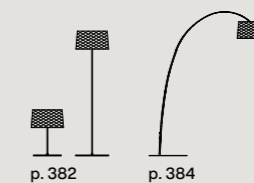
Materiale composito su base di fibra di vetro laccato, PMMA, metallo verniciato e alluminio.
Varnished fibreglass based composite material, PMMA, varnished metal and aluminium.

Colori — *Colors*
Carminio, greige.
Carmine, greige.



Collection

Discover more



Uto

Outdoor suspension



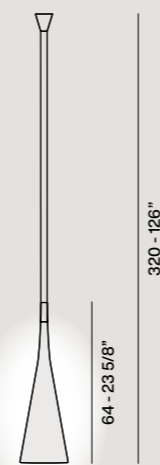


Uto, design Lagranja Design, 2005

Outdoor suspension

Una lampada fuori dagli schemi che permette di inserire punti luce in modo flessibile dialogando con quanto c'è attorno: elementi strutturali – edifici, arredi urbani – ma anche naturali – alberi, rampicanti. Realizzata in gomma silconica: un materiale piacevole, morbido al tatto, antiurto e indistruttibile. Può essere utilizzata in interno e in esterno, modellandola a seconda delle esigenze e ispirazioni personali.

An unconventional lamp that permits insertion of lighting points in a flexible way, establishing a dialogue with the surroundings: structural elements like buildings and urban furnishings, but also natural features like trees and vines. Made in silicone rubber, a material that is pleasing and soft to the touch, ready to stand up to impact, and indestructible. For indoor and outdoor use, shaped to meet personal needs and inspirations.



20 - 7 7/8"

64 - 23 5/8"

320 - 126"

Elastomero termoplastico e policarbonato.
Thermoplastic elastomer and polycarbonate.

Colori — *Colors*
Bianco, giallo, arancio.
White, yellow, orange.



Collection



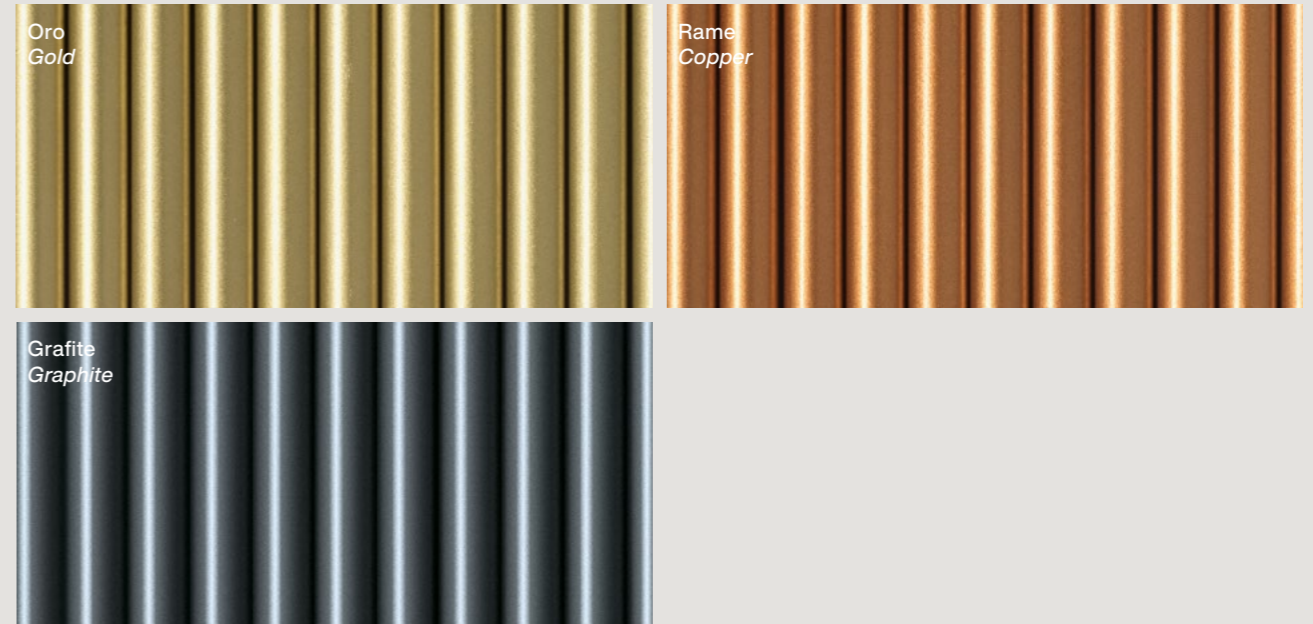
p. 258

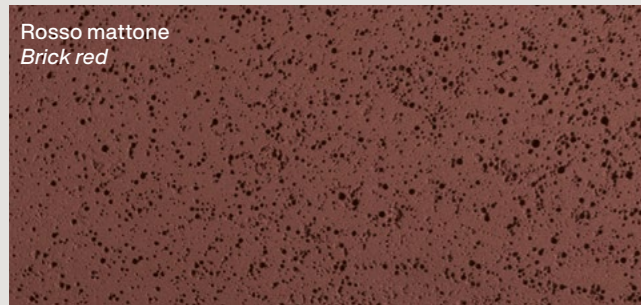
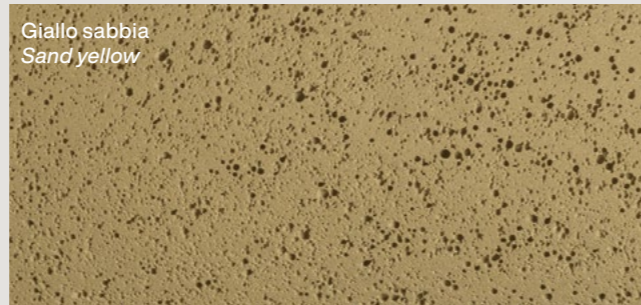
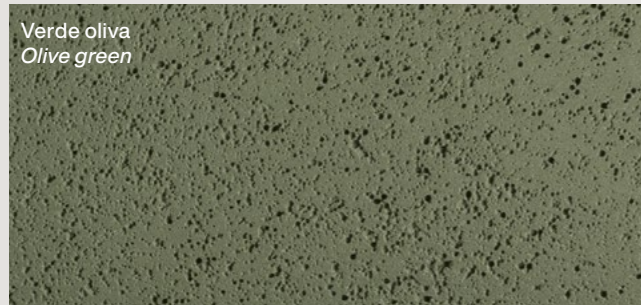
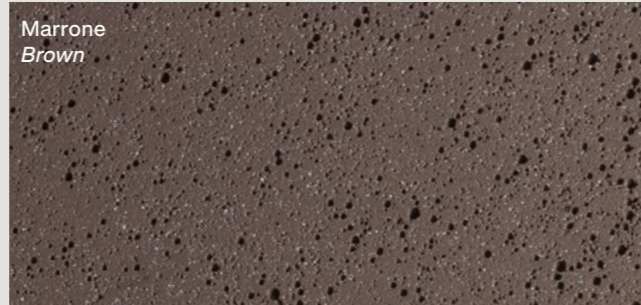
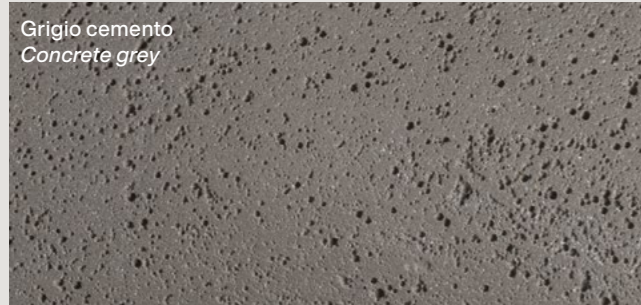
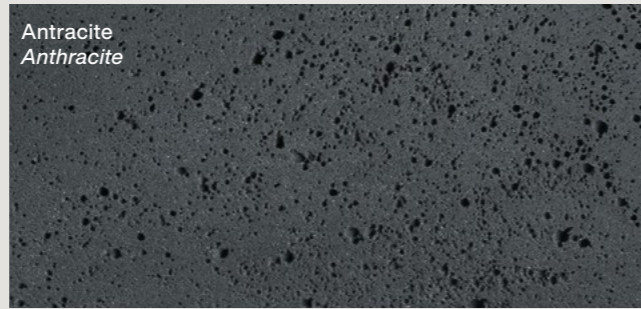
Discover more



Color Samples

395	Allegro	404	Mite
396	Aplomb	404	Mite Anniversario
397	Aplomb Outdoor	405	Spokes
398	Birdie	406	Tonda
399	Birdie Easy	407	Tress
400	Chapeaux	408	Twiggy
401	Fleur	409	Twiggy Grid
402	Lumiere	409	Twiggy Wood
402	Lumiere Nuances		
402	Lumiere 30 th		



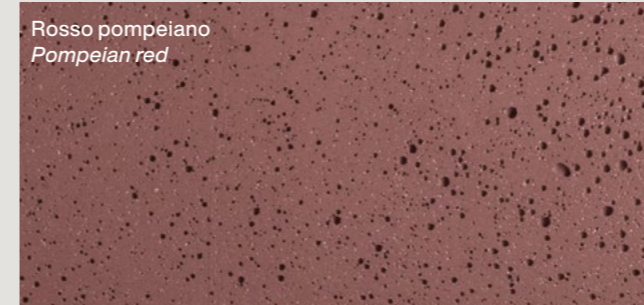
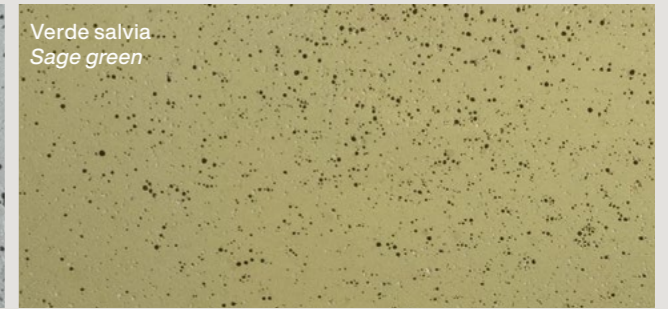
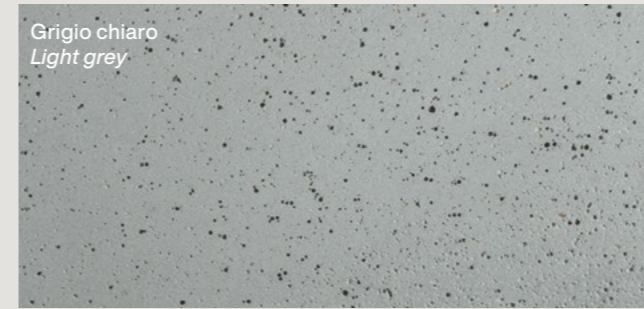


Colori disponibili
Aplomb: bianco, antracite,
grigio cemento, marrone,
verde oliva, giallo sabbia,
rosso mattone.

Aplomb mini / Aplomb Large:
bianco, antracite, grigio
cemento, marrone.

Available colors
Aplomb: white, anthracite,
concrete grey, brown,
olive green, sand yellow,
brick red.

Aplomb mini / Aplomb Large:
white, anthracite, concrete
grey, brown.



Color samples

Bianco
White

Grigio
Grey

Grafite
Graphite

Rame
Copper

Color samples

Bianco
White

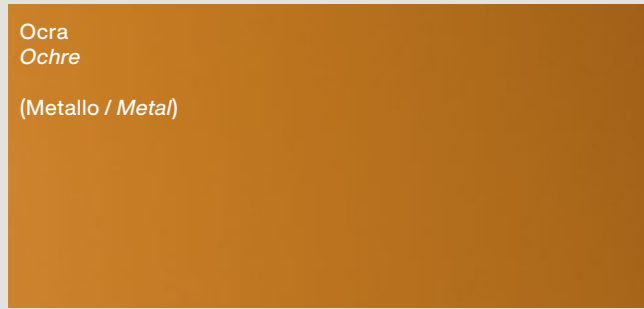
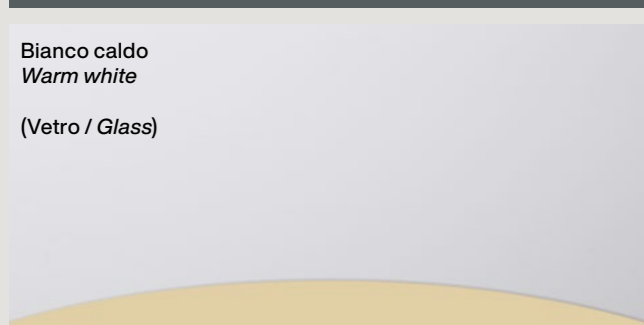
Nero
Black

Rosso mattone
Brick red

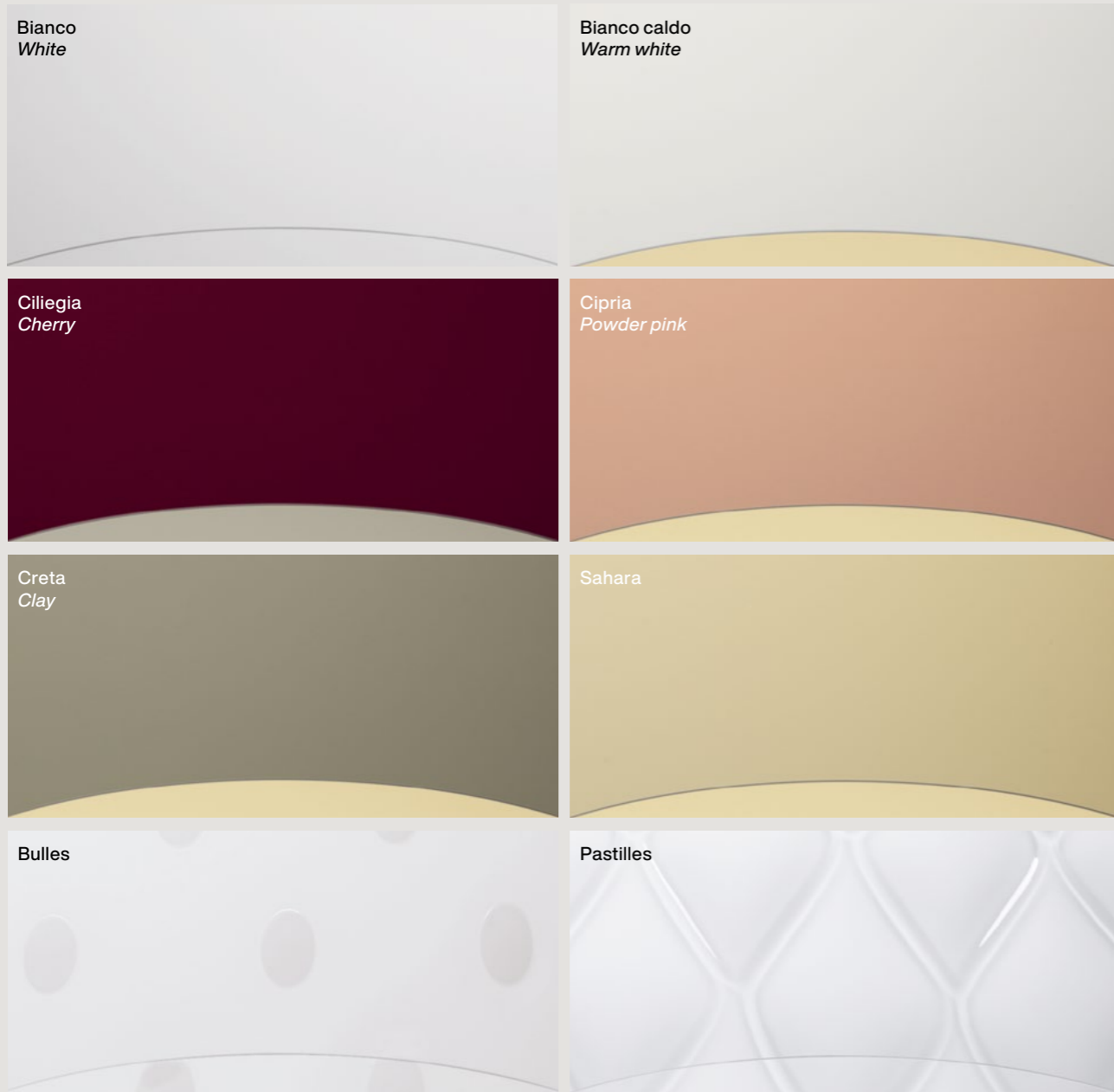
Azzurro
Light blue

Giallo sabbia
Sand yellow

Verde salvia
Sage green

<p>Ocra <i>Ochre</i></p> <p>(Metallo / <i>Metal</i>)</p> 	<p>Rosso scuro <i>Dark red</i></p> <p>(Metallo / <i>Metal</i>)</p> 
<p>Grigio <i>Grey</i></p> <p>(Metallo / <i>Metal</i>)</p> 	<p>Bianco <i>White</i></p> <p>(Porcellana / <i>Porcelain</i>)</p> 
<p>Bianco caldo <i>Warm white</i></p> <p>(Vetro / <i>Glass</i>)</p> 	<p>Grigio <i>Grey</i></p> <p>(Vetro / <i>Glass</i>)</p> 

<p>Burgundy <i>Burgundy</i></p> 	<p>Bianco <i>White</i></p> 
<p>Verde salvia <i>Sage green</i></p> 	

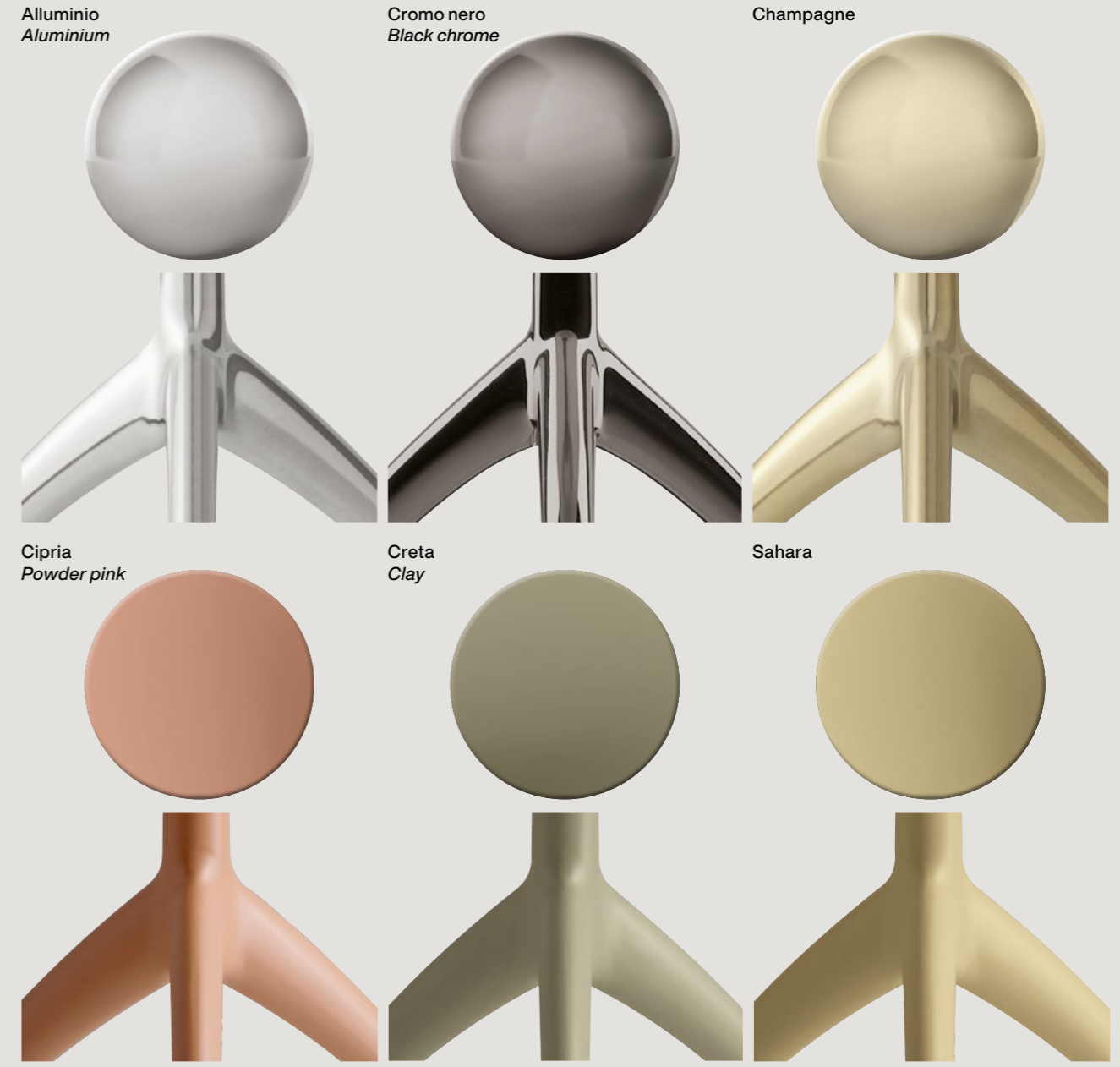


Colori disponibili
Lumiere: bianco, bianco caldo, ciliegia.
Lumiere Nuances: cipria, creta, sahara.

Lumiere 30th: bulles, pastilles.

Available colors
Lumiere: white, warm white, cherry.
Lumiere Nuances: powder pink, clay, sahara.

Lumiere 30th: bulles, pastilles.

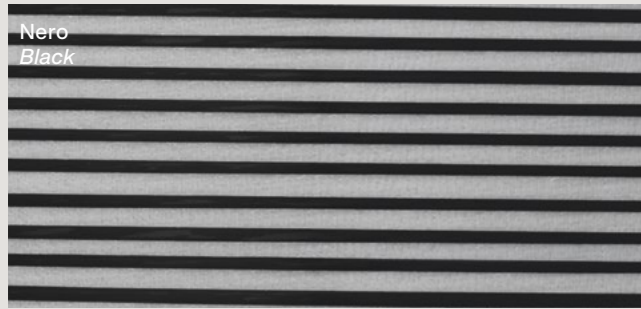


Colori disponibili
Lumiere: alluminio, cromo nero, champagne.
Lumiere Nuances: cipria, creta, sahara.

Lumiere 30th: champagne.

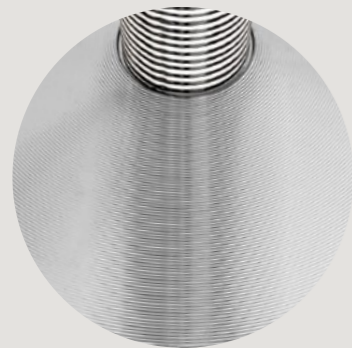
Available colors
Lumiere: aluminium, black chrome, champagne.
Lumiere Nuances: powder pink, clay, sahara.

Lumiere 30th: champagne.



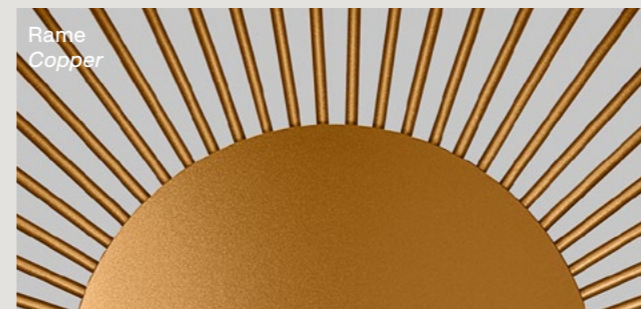
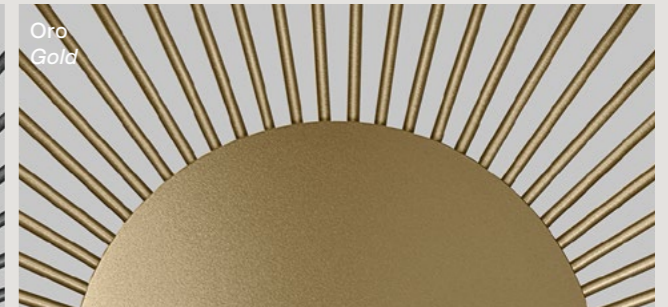
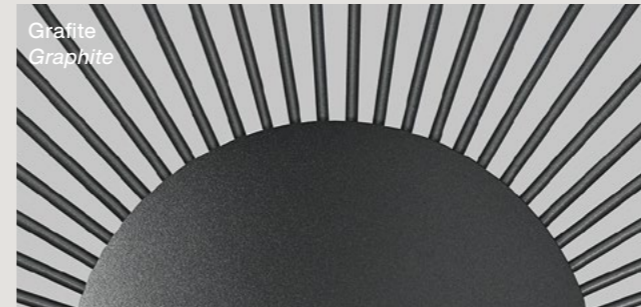
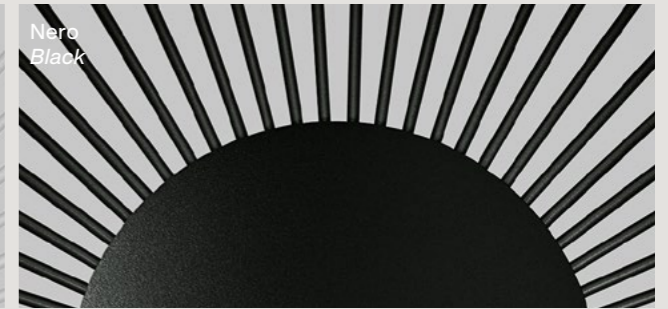
Mite base

Nichelato
Nickel-plated



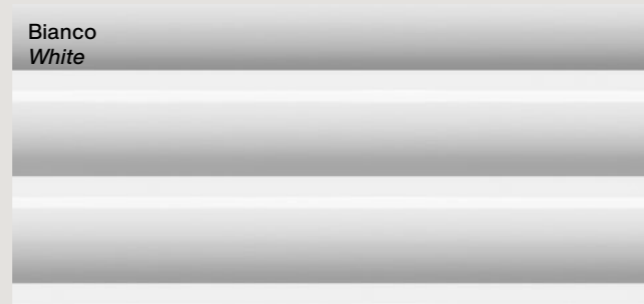
Mite Anniversario base

Marmo marquina
Marquina marble

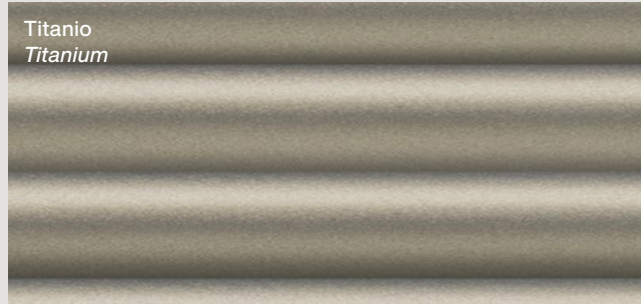




Arancio
Orange



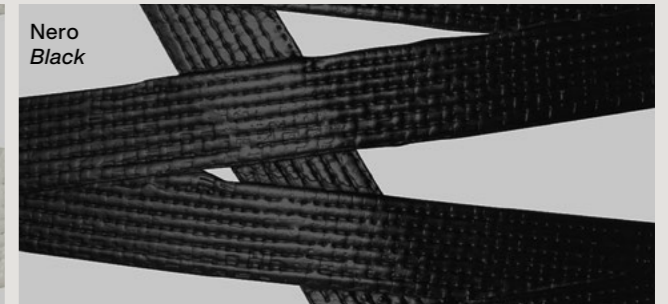
Bianco
White



Titanio
Titanium



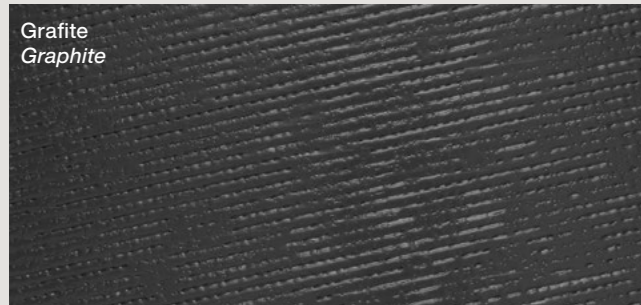
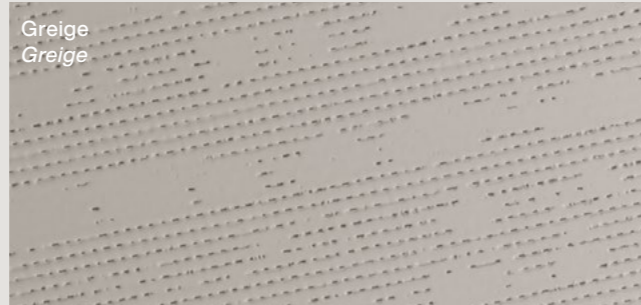
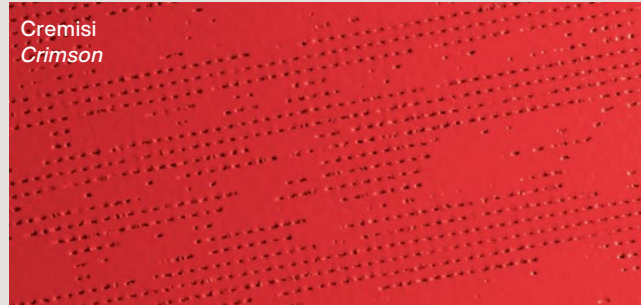
Bianco
White



Nero
Black



Greige
Greige



Colori disponibili
Twiggy / Twiggy Elle:
bianco, nero, cremisi, greige,
grafite, burgundy.
Twiggy Lettura: bianco,
nero, burgundy.

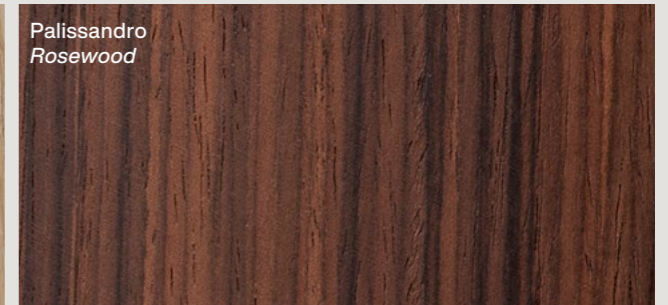
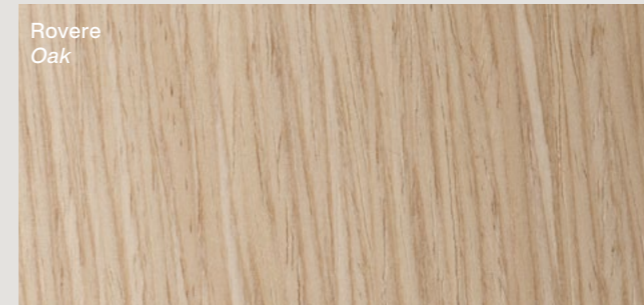
Twiggy sospensione
/ Twiggy soffitto: bianco,
nero.

Available colors
Twiggy / Twiggy Elle: white,
black, crimson, greige,
graphite, burgundy.
Twiggy Lettura: white,
black, burgundy.

Twiggy suspension
/ Twiggy ceiling: white,
black.



Twiggy Wood — Floor → p. 142 / Suspension → p. 254



Light sources

Model	Version	Type 220 / 240V	Type 120V
Allegretto	Suspension	Max 2x100W E27 PAR 30	Max 2x75W E26 PAR 30
Allegro	Suspension	Max 1x300W R7s + 1x100W E27 PAR 30	Max 1x200W RSC + Halo 1x75W E26 PAR 30
Allegro LED	Suspension	LED included 51W 3000K 5684 lm CRI>90	LED included 56W 3000K 5684 lm CRI>90
Anisha grande	Table	LED included 4,5W 3000K 400 lm CRI>80	LED included 4,5W 3000K 400 lm CRI>80
Anisha piccola	Table	LED included 3,4W 3000K 300 lm CRI>80	LED included 3,4W 3000K 300 lm CRI>80
Aplob / Aplob mini	Suspension	Max 1x8W GU10 PAR 16	Max 1x9W GU10 PAR 16
Aplob Large	Suspension	LED included 11,7W 2700K 1279 lm CRI>90	LED included 9,2W 2700K 897 lm CRI>90
Aplob	Wall	Max 1x17,5W R7s	LED included 14W 2700K 1120 lm CRI > 80
Aplob Outdoor	Suspension	LED included 8W 2700K 680 lm CRI>90	LED included 8W 2700K 680 lm CRI>90
Bahia	Ceiling / Wall	LED included 43W 2850K 5240 lm CRI>90	LED included 43W 2850K 5240 lm CRI>90
Bahia mini	Ceiling / Wall	LED included 21W 2850K 2620 lm CRI>90	LED included 25W 2850K 2620 lm CRI>90
Big Bang	Suspension	Max 1x160W R7s	Max 1x200W RSC
Big Bang LED	Suspension	LED included 37W 3000K 3260 lm CRI>90	LED included 41W 3000K 3260 lm CRI>90
Big Bang L	Suspension	LED included 58W 3000K 6084 lm CRI>90	LED included 66W 3000K 6084 lm CRI>90
Big Bang XL	Suspension	LED included 87W 3000K 9126 lm CRI>90	LED included 98W 3000K 9126 lm CRI>90
Big Bang	Ceiling / Wall	Max 1x120W R7s	Max 1x100W RSC
Binic	Table	Max 1x12W E14	Max 1x12W E12
Birdie grande	Table / Lettura	Max 1x150W E27	Max 1x150W E26 type A
Birdie piccola	Table / Suspension	Max 1x70W E27	Max 1x70W E26 type A
Birdie LED	Table / Lettura	LED included 8,4 W 2700K 655 lm CRI>80	LED included 8,4 W 2700K 655 lm CRI>80
Birdie grande	Suspension	Max 1x105W E27	Max 1x100W E26 type A
Birdie	Wall	Max 1x70W E27	Max 1x60W E26 type A
Birdie Easy	Table / Lettura	Max 1x57W E27	Max 1x57W E26 type A
Birdie Zero grande piccola	Table	Max 1x57W E27	Max 1x57W E26 type A
Bit	Wall	Max 1x46W E14	Max 1x60W E12 type G
Bridge 1	Table	LED included 7,8W 2700K 822 lm CRI>90	LED included 7,8W 2700K 822 lm CRI>90
Bridge 2	Table	LED included 3,6W 2700K 352 lm CRI>90	LED included 3,6W 2700K 352 lm CRI>90
Buds 1-2	Table	Max 1x23W E27	Max 1x23W E26
Buds 3	Table	Max 1x15W E27	Max 1x15W E26
Buds 1-2-3	Suspension	LED retrofit included 21W E27 2700K 2451 lm CRI>80	Max 1x60W E26
Buds 1-2-3 LED	Suspension	LED included 23W 2700K 2291 lm CRI>90	LED included 23,9W 2700K 2581 lm CRI>90
Bump	Suspension	Max 1x30W E27	Max 1x30W E26 type A
Caboche Plus	Table	LED included 10W 2700K 930 lm CRI>90	LED included 8W 2700K 680 lm CRI>80
Caboche Plus grande	Table / Suspension	LED included 28W 2700K 3850 lm CRI>90	LED included 33,5W 2700K 3850 lm CRI>90
Caboche Plus media	Table / Suspension	LED included 23W 2700K 3200 lm CRI>90	LED included 27W 2700K 3200 lm CRI>90
Caboche Plus piccola	Suspension	LED included 7W 2700K 1000 lm CRI>90	LED included 9,5W 2700K 1000 lm CRI>90
Caboche Plus	Ceiling	LED included 26W 2700K 3645 lm CRI>90	LED included 32,5W 2700K 3645 lm CRI>90
Caboche Plus media	Wall	Max 1x17,5W R7s	LED included 16 W 2700K 1360 lm 85 lm/W CRI>80
Caboche Plus piccola	Wall	Max 1x17,5W R7s	LED included 12 W 2700K 1020 lm 85 lm/W CRI>80
Chapeaux	Table	LED included 7,5W 2700K 900 lm CRI>90	LED included 7,5W 2700K 900 lm CRI>90
Chiaroscuro	Floor	LED included 37W 2700K 4730 lm CRI>80	LED included 42,5W 2700K 4730 lm CRI>80
Chouchin 1-2-3/Bianco/Reverse	Suspension	LED retrofit included 21W E27 2700K 2451 lm CRI>80	Max 1x60W E26 type A
Chouchin 1-2-3 LED/Bianco/Reverse	Suspension	LED included 24W 2700K 2581 lm CRI>90	LED included 23W 2700K 2291 lm CRI>90
Chouchin 2-3	Ceiling	LED retrofit included 18W E27 2700K 2452 lm CRI>80	18W E26 2700K 2452 lm CRI>80
Chouchin semi	Wall	Max 1x30W E27	Max 1x30W E26 type A
Circus grande	Ceiling / Wall	Max 4x60W E27	Max 4x40W E26 type A
Circus piccola	Ceiling / Wall	Max 4x40W E14	Max 4x25W E12 type G
Cri Cri	Table / Floor	LED included 2,4W 2700K 325 lm CRI>80	LED included 2,4W 2700K 325 lm CRI>80
Dolmen	Floor	LED included 47W 2700K 6486 lm CRI>90	LED included 41W 2700K 4980 lm CRI>90
Double	Wall	Max 2x77W E27	Max 2x100W E26 type A
Fields	Wall	Flo 1x80W G5 + 1x54W G5 + 1x39W G5	Flo 1x80W G5 + 1x54W G5 + 1x39W G5
Filo	Table / Floor / Wall	LED retrofit included 4W G9 3000K 400 lm CRI>80	Max 1x4W G9
Fleur	Table	LED included 1,6W 3000K 9188 lm CRI>90	LED included 1,6W 3000K 9188 lm CRI>90
Folio	Ceiling	Max 1x120W R7s	Max 1x100W RSC
Folio	Wall	Max 1x120W R7s	Max 1x150W RSC
Gem	Table	Max 1x150W E27	Max 1x70W E26
Gem	Floor	Max 1x57W E27	Max 1x60W E26
Gem	Suspension	24W 2700K 2581 lm CRI>90	Max 1x100W E26 type A
Gem LED	Suspension	LED included 21W 2700K 2451 lm CRI>80	LED included 23W COB 2700K 2291 lm CRI>90
Gem	Ceiling	LED retrofit included 18W E27 2700K 2452 lm CRI>80	18W E26 2700K 2452 lm CRI>80
Gem semi	Wall	Max 1x30W E27	Max 1x30W E26 type A
Gioia	Wall	LED included 10W 2700K 790 lm CRI>90	LED included 10W 2700K 795 lm CRI>80
Gregg grande	Table	Max 1x150W E27	Max 1x150W E26
Gregg media	Table	Max 1x150W E27	Max 1x100W E26
Gregg midi	Table / Suspension / Ceiling / Wall	LED retrofit included 1x6,5W E14 2700K 806 lm CRI>80	Max 1x20W E12 LED type G
Gregg piccola	Table / Suspension / Ceiling / Wall	Max 1x8W G9	Max 1x8W G9
Gregg	Floor	Max 1x57W E27	Max 1x60W E26
Gregg grande	Suspension	LED retrofit included 21W E27 2700K 2451 lm CRI>80	Max 1x100W E26 type A
Gregg media	Suspension	LED retrofit included 21W E27 2700K 2451 lm CRI>80	Max 1x60W E26 type A
Gregg grande / media LED	Suspension	LED included 24W 2700K 2581 lm CRI>90	LED included 23W COB 2700K 2291 lm CRI>90
Gregg grande	Ceiling	LED retrofit included 18W E27 2700K 2452 lm CRI>80	18W E26 2700K 2452 lm CRI>80
Gregg media	Ceiling / Wall	LED retrofit included 18W E27 2700K 2452 lm CRI>80	Max 1x100W E26 type A
Gregg semi	Wall	Max 1x30W E27	Max 1x30W E26 type A
Gregg Outdoor XL / grande	Table / Floor / Suspension	Max 1x25W E27	Max 1x25W E26 type A
Gregg Outdoor media	Table / Floor / Suspension	Max 1x15W E27	Max 1x15W E26 type A
Gregg Outdoor midi	Wall	LED included 8W 2700K 635 lm CRI>90	LED included 8W 2700K 665 lm CRI>80
Gregg Outdoor piccola	Wall	Max 1x8W LED retrofit G9	
Havana	Floor	Max 1x150W E27	Max 1x150W E26
Havana	Suspension	Max 1x105W E27	Max 1x100W E26 type A

Light sources

Model	Version	Type 220 / 240V	Type 120V
Havana	Wall	Max 1x116W E27	Max 1x100W E26 type A
Havana Outdoor	Floor / Suspension	Max 1x46W E27	Max 1x60W E26 type A
Kurage	Table	Max 1x20W E27	Max 1x20W E26
Lake	Wall	LED included 10W 3000K 862 lm CRI>90	LED included 10W 3000K 850 lm CRI>80
Le Soleil	Suspension	Max 3x70W E27 + 1x75W GU10 PAR 16	Max 3x70W E26 type A + Halo 1x75W GU10
Le Soleil	Wall	Max 1x17,5W R7s	
Light Bulb	Table	LED included 3W 2700K 440 lm 146 lm/W CRI>80	LED included 3W 2700K 440 lm 146 lm/W CRI>80
Lightweight	Suspension	Max 8x20W G4 12v	Max 8x20W G4 12v
Lumiere/Lumiere 30 th /Lumiere Nuances grande	Table	LED retrofit included 1x11W E27 2700K 1521 lm CRI>80	Max 1x25W E26 type A
Lumiere/Lumiere 30 th /Lumiere Nuances piccola	Table	LED retrofit included 1x6,5W E14 2700K 806 lm CRI>80	Max 1x25W E12 type G
Lumiere XXL	Table / Floor	Max 4x33W G9	Max 4x40W G9
Lumiere XXS	Table	Max 1x48W G9	Max 1x40W G9
Lumiere XXL	Ceiling / Wall	Max 4x8W G9	LED included 32W 2700K 2720 lm CRI>80
Lumiere XXS	Ceiling / Wall	Max 3x8W G9	LED included 18W 2700K 1512 lm CRI>80
Madre	Table	LED included 16W 2700K 1445 lm CRI>80	LED included 17W 2700K 1500 lm CRI>80
Magneto	Table / Floor	LED included 5W 2700 K 475 lm CRI>80	LED included 5W 2700 K 475 lm CRI>80
Mite	Floor	Max 1x150W E27	Max 1x150W E26
Mite LED / Mite Anniversario	Floor	LED included 24W COB 2700K 3530 lm CRI>90	LED included 28W 2700K 3530 lm CRI>90
Nile	Table	LED retrofit included 1x18W E27 2700K 2452 lm CRI>80	Max 1x18W E26 type A
Nuée	Suspension	LED included 29W 3000K 3749 lm CRI>90	LED included 34W 3000K 3749 lm CRI>90
Orbital	Floor	Max 5x40W E14	Max 5x40W E12
Plass media	Table	Max 1x150W E27	Max 1x150W E26
Plass grande	Suspension	LED included 30W 3000K 2500 lm CRI>80 + LED retrofit included 1x9,5W 2700 K 650 lm E27 PAR 30	LED included 30W 3000K 2500 lm CRI>80 + 1x12W E26 PAR 30
Plass media E27+GU10	Suspension	Max 1x116W E27 + 1x75W GU10 PAR 20	Max 1x100W E26 type A + 1x50W GU10
Plass media E27	Suspension	Max 1x116W E27	
Plena	Suspension	LED included 32W 2700K 3530 lm CRI>90	LED included 40W 2700K 3530 lm CRI>90
Poly Gregg XL / grande	Table	Max 1x25W E27	Max 1x25W E26
Poly Gregg media	Table	Max 1x15W E27	Max 1x15W E26
Rituals 1-2-3	Table	Max 1x105W E27	Max 1x100W E26 type A
Rituals XL	Table	Max 1x150W E27	Max 1x150W E26 type A
Rituals	Floor	Max 1x57W E27	Max 1x60W E26 type A
Rituals 1-2-3	Suspension	Max 1x70W E27	Max 1x60W E26 type A
Rituals 1-3	Ceiling	LED retrofit included 1x11W E27 2700K 1521 lm CRI>80	Max 1x70W E26 type A
Rituals 2	Ceiling / Wall	LED retrofit included 1x1W E27 2700K 1521 lm CRI>80	1x11W E26 2700K 1521 lm CRI>80
Rituals 1-3	Wall	Max 1x70W E27	Max 1x70W E26 type A
Rituals 1-3 doppia	Wall	Max 2x70W E27	Max 2x60W E26 type A
Rituals XL	Suspension	LED retrofit included 21W E27 2700K 2451 lm CRI>80	Max 1x100W E26 type A
Rituals XL	Ceiling	LED retrofit included 1x18W E27 2700K 2452 lm CRI>80	1x18W E26 2700K 2452 lm CRI>80
Rituals XL LED	Suspension	LED included 24W 2700K 2581 lm CRI>90	LED included 23W COB 3000K 2291 lm CRI>90
Rituals semi	Wall	Max 1x30W E27	Max 1x30W E26 type A
Satellite	Table	LED included 8,4W 2700K 655 lm CRI>80	LED included 8,5W 2700K 655 lm CRI>80
Satellite	Suspension	LED retrofit included 21W E27 2700K 2451 lm CRI>80	Max 1x60W E26 type A
Satellite	Wall	Max 1x25W G9	LED included 6W 2700K 504 lm CRI>80
Soffio	Table	LED included 13,8W 2700K 1300 lm CRI>80	LED included 13,8W 2700K 1300 lm CRI>80
Solar	Floor	Max 1x25W E27	Max 1x25W E26 type A
Spokes 1-2-midi-Large-3	Suspension	LED included 30W 2700K 3316 lm CRI>90	LED included 40W 2700K 3935 lm CRI>90
Spokes piccola	Suspension	LED included 19W 2700K 2237 lm CRI>90	LED included 22W 2700K 2237 lm CRI>90
Sun-Light of Love	Suspension	LED included 32W 2700K 3170 lm CRI>90	LED included 38W 2700K 3170 lm CRI>90
Supernova	Suspension	Max 1x150W E27	Max 1x100W E26 type A
Tartan	Suspension	LED retrofit included 21W E27 2700K 2451 lm CRI>80	Max 1x100W E26 type A
Tartan LED	Suspension	LED included 24W 2700 K 2581 lm CRI>90	LED included 23W COB 2700K 2291 lm CRI>90
Tartan	Ceiling	LED retrofit included 1x18W E27 2700K 2452 lm CRI>80	1x18W E27 2700K 2452 lm CRI>80
Tite 1-2	Suspension	Max 1x116W E27	Max 1x100W E26
Tobia	Floor	LED included 15W 2700K 2000 lm CRI>80	LED included 15W 2700K 2000 lm CRI>80
Tobia	Wall	LED included 12 (6+6)W 2700K 1400 lm CRI > 80	LED included 12 (6+6)W 2700K 1400 lm CRI > 80
Tonda	Suspension	LED retrofit included 20W E27 2700K 2452 lm CRI>80	Max 1x20W LED E26 type A
Tonda piccola	Suspension	LED retrofit included 14W E27 2700K 1521 lm CRI>90	Max 1x14W LED E26 type A
Tress grande	Floor	Max 1x250W R7s + 100W E27 PAR 30	Max 1x150W RSC + 1x75W E26 PAR
Tress grande LED	Floor	LED included 56W 2700K 5624 lm CRI>90	LED included 65W 2700K 4830 lm CRI>90
Tress media	Floor	Max 1x100W E27 PAR 30	Max 1x75W E26 PAR 30
Tress media / piccola	Suspension	220/240V: Max 1x100W E27 PAR 30	Max 1x75W E26 PAR 30
Tress mini	Suspension	Max 1x75W GU10 PAR 20	Max 1x75W GU10 PAR 16
Tress grande	Suspension	Max 1x160W R7s	Max 1x200W RSC
Tress grande LED	Suspension	LED included 28W 2700K 3840 lm CRI>90	LED included 41W 3000K 3062 lm CRI>90
Tress	Wall	Max 1x120W R7s	Max 1x100W RSC
Troag	Suspension	LED included 43W 3000K 6080 lm CRI>90	LED included 50W 3000K 6800 lm CRI>90
Tuareg	Floor	LED included 46W 3000K 4560 lm CRI>90	LED included 59W 3000K 4050 lm CRI>90
Tutù	Wall	Max 2x46W E14	Max 2x40W E12 type G
Twice as Twiggy	Floor	LED included 81W 3000K 8517 lm CRI>90	LED included 95W 3000K 8517 lm CRI>90
Twice as Twiggy	Suspension	LED included 81W 3000K 8517 lm CRI>90	LED included 98W 3000K 8517 lm CRI>90
Twiggy	Floor / Suspension	Max 3x77W E27	Max 3x100W E26 type A
Twiggy	Lettura / Ceiling	Max 3x77W E27	Max 3x100W E26 type A
Twiggy LED / Twiggy Wood / Twiggy Elle	Floor	28W 2700K 3840 lm CRI>90	34W 2700K 3840 lm CRI>90
Twiggy LED / Twiggy Wood	Suspension	28W 2700K 3840 lm CRI>90	33W 2700K 3840 lm CRI>90
Twiggy Grid	Table / Floor / Lettura	LED included 32W 2850K 3930 lm CRI>90	LED included 36,5W 2850K 3930 lm CRI>90
Twiggy Grid	Suspension	LED included 26W 2850K 3368 lm CRI>90	LED included 31W 2850K 3368 lm CRI>90
Uptown	Floor	LED included 17,7W 2700K 2498 lm CRI>80	LED included 21W 2700K 2498 lm CRI>80
Uto	Suspension	Max 1x12W E27	Max 1x12W E26 type A

Vite

Un progetto per scoprire la luce di Foscarini nelle case degli altri. Un racconto per immaginare quella luce nelle nostre. Nato nel 2018, VITE è un viaggio che ci ha portato in tre continenti, tredici città, venticinque case per mostrare la capacità delle lampade Foscarini di portare carattere, ma anche di adattarsi. Di non richiedere la scena, ma di contribuire a crearla. Abbiamo cercato ambienti molto personali, anche imperfetti perché veri, inevitabilmente lontani dai set fotografici controllati e dalle fredde regole di styling tipiche degli scatti del mondo del design. Con VITE proponiamo il design nella sua dimensione più umana. Quel design che esprime le sue qualità nelle abitazioni di persone che vivono le case come specchi: per vedersi e non mostrarsi, per trovarsi e non esporsi. Scopri VITE in versione digitale. Lasciati ispirare con una selezione più ampia di immagini, navigabile per ambiente, prodotto o funzione d'uso.

A project to discover Foscarini lights in the homes of others. A story to imagine those lights in ours. Since 2018, we have embarked on a journey across three continents, visiting 13 cities and 25 homes to showcase the ability of Foscarini lamps to give any space character, but also to blend in. Contributing to and enhancing the setting without taking over or imposing. We purposely sought out personal settings, which are also imperfect because they are real. Far from traditional posed design photography and its cold rules of styling. Our goal with VITE is to present design in its most human form. Design that conveys its qualities in the dwellings of people, for whom the home is like a mirror: to see themselves, not to show off; a question of encounters, not of display. Experience the digital version of VITE and be inspired by a vast selection of images categorized by room, product or function.

→ www.vite.foscarini.com

Discover more



Altri cataloghi / *Other catalogs*

Maestrie — È l'ampio progetto che mette in luce il sapere artigiano alla base della realizzazione di alcune delle icone Foscarini.

Ritratti — Un "design book", una selezione di lampade raccontate con differenti mood, attraverso i diversi punti di vista e sensibilità di tre fotografi, in un viaggio all'interno di cinque abitazioni in giro per l'Italia e nei suggestivi spazi outdoor dell'Arsenale di Venezia.

Ambienti — Progettare significa scegliere, e scegliere una lampada significa mettere in scena la giusta luce.

Un catalogo che parla di progetti per aiutare a tradurre idee di luce in spazi "illuminati".

Maestrie — Is an extensive project which sheds light on the craftsmanship skills at the heart of the production of some of Foscarini's iconic products.

Ritratti — ("Profiles"), a brand book takes an intimate tour of five homes across Italy and an outdoor setting: the breathtaking night views of Arsenale in Venice.

A collection of independent expressions on living photographed by three interior photographers.

Ambienti — Designing means choosing, and choosing a lamp means staging the right light. A catalog that talks about projects to help designers translate ideas of light into "enlightened" spaces.

→ www.foscarini.com/en/downloads



MyFoscarini

Nel rapporto con i propri partner e clienti, Foscarini si serve di strumenti "disegnati" al proprio interno, nel segno dell'efficienza e della trasparenza: come *MyFoscarini*, la piattaforma informatica riservata ai propri rivenditori, uno strumento innovativo per completezza delle informazioni e funzionalità. In pochi click, con *MyFoscarini* è possibile collegarsi alla rete aziendale per:

- verificare la disponibilità delle lampade e la data di spedizione;
 - inserire un ordine, prenotando così direttamente il modello richiesto;
 - tenere traccia della spedizione;
 - consultare le condizioni di vendita;
 - scaricare i documenti amministrativi come bolle e fatture;
- Il tutto 7 giorni su 7, 24 ore su 24. Se non sei già registrato richiedi la tua password al Customer Care Foscarini.

With the same spirit that provides new ideas in lighting design, Foscarini creates its own more efficient programs for customer and partner communication, for instance, MyFoscarini, a proprietary IT platform, an absolutely innovative, highly flexible and transparent tool providing customers with complete information and full range of functions. With just a few clicks in MyFoscarini you can:

- check the availability of lamps and the shipping date;
- enter your orders, reserving lamps directly from Foscarini's central system;
- track your order status;
- consult sale conditions;
- download admin documents such as transport documents and invoices.

And all this 7 days a week, 24 hours a day. If you haven't registered yet request your password from Foscarini Customer Care.

→ myf2.foscarini.com

Social media

Foscarini è attiva sui principali social network, con stili e obiettivi specifici per ciascuna piattaforma:

- Su *Instagram* raccontiamo creativamente il brand, le collezioni, gli eventi e incoraggiamo ambassador e utenti a condividere foto delle lampade Foscarini.
- *Facebook* è il nostro amplificatore per progetti e prodotti e offre assistenza ai consumatori.
- La nostra bacheca *Pinterest* è uno strumento di ispirazione per l'interior design, organizzando i migliori progetti per modello, materiale, colore, ambiente e funzione.
- Su *LinkedIn* coltiviamo rapporti con i professionisti, raccontiamo Foscarini e i progetti che ci guidano.

Foscarini is active on the major social networks, with tailored styles and objectives for each platform:

- On Instagram, we creatively showcase our brand, products, and events while encouraging ambassadors and users to share photos of Foscarini lamps.
- Facebook is an amplifier for our projects and products and offers consumer-focused customer service.
- Our Pinterest board offers valuable interior design inspiration, categorizing top projects for an easy navigation.
- On LinkedIn, we cultivate industry connections, talk about Foscarini, and the projects driving our company forward.

Inventario

Inventario è un progetto editoriale che parla di tutte le discipline alimentate dalla creatività. Un bookzine che dal 2010 archivia, indaga, crea ponti, accende idee: stimola a osservare ciò che ci circonda con uno sguardo più curioso, illuminato e libero ogni giorno. Fondato, promosso e sostenuto da Foscarini, diretto da Beppe Finessi ed edito da Corraini Edizioni, Inventario incarna la filosofia dell'azienda: dove "tutto è progetto". Nel 2014, Inventario è stato premiato con il Compasso d'Oro ADI. È disponibile nei migliori bookshop e librerie o sul sito www.corraini.com.

Inventario is a publishing concept that describes all the disciplines that merge into the melting pot of creativity. Since 2010 it has been a bookzine that files away, investigates, builds bridges, and sparks ideas. It stimulates us to observe our surroundings with a more curious, enlightened, and free perspective every day. Founded, promoted and supported by Foscarini, directed by Beppe Finessi and published by Corraini, Inventario embodies the company's philosophy: "everything is a project". In 2014, Inventario was honored with the Compasso d'Oro ADI award. It is available in select bookstores or online at www.corraini.com



Certificazioni / Certifications



CE

Dichiara che il produttore produce apparecchi conformi e rispondenti ai requisiti proposti dalla norma EN 60598.

Declares that the manufacturer produces light fittings which comply with the requirements of the EN 60598.



ETL

Certifica che il prodotto è conforme agli standard di sicurezza nordamericani. La certificazione ETL è rilasciata da Intertek, società terza indipendente per test, ispezioni e certificazioni.

The ETL Mark is proof of product compliance to North American safety standards. The ETL certification is issued by Intertek, an independent Third Party company for testing, inspection and certification.



Classe I

Apparecchio in classe I°: è obbligatoria la connessione al conduttore di protezione giallo / verde (messa a terra).

Class I° luminaire: it's necessary to connect the device to the yellow / green protective conductor (earthing).



Classe II

Apparecchio in cui la protezione contro la scossa elettrica si basa unicamente sul doppio isolamento e/o isolamento rinforzato in ogni parte e senza dispositivo di messa a terra.

Light fittings whose safety is guaranteed only by the double and/or reinforced insulation of all parts, with no earth.



Classe III

Apparecchio in cui la protezione contro la scossa elettrica si basa sull'alimentazione a bassissima tensione di sicurezza e in cui non si producono tensioni superiori alla stessa.

Light fittings in which protection against electric shock is designed to be supplied from a safety extra-low voltage power source.



IP Protection Degree

IP20: apparecchio protetto contro la penetrazione di corpi solidi di dimensioni maggiori a 12mm e non protetto nei confronti dei liquidi.

IP44: apparecchio protetto contro la penetrazione di corpi solidi di dimensioni maggiori a 1mm e protetto contro gli spruzzi d'acqua. **IP65:** apparecchio totalmente protetto contro la polvere e protetto contro i getti d'acqua.

IP20: protected against the penetration of solid objects greater than 12 mm and non protected against liquids.

IP44: protected against the penetration of solid objects greater than 1 mm and protected against splashing water.

IP65: dust-tight and protected against water jets.



CSQ – IQNET

Marchio valido in tutto il mondo, certifica che l'azienda Foscarini attua un sistema di gestione della qualità conforme alla normativa UNI EN ISO 9001:2015, per garantire un elevato standard qualitativo nella progettazione, sviluppo, fabbricazione e commercializzazione dei propri prodotti.

The CSQ-IQNET label is valid all over the world. It certifies that Foscarini runs a quality management system which complies with the UNI EN ISO 9001:2015 standard, to guarantee a high quality level for what concerns project, development, production and distribution of its products.



CSQ ECO

Marchio valido in tutto il mondo, certifica che l'azienda Foscarini attua un sistema di gestione ambientale conforme alla normativa UNI-EN ISO 14001:2015 per garantire l'impegno dell'azienda ad operare nel rispetto dell'ambiente e con l'obiettivo continuo di ridurre l'impatto delle proprie attività.

This label is valid all over the world. It certifies that Foscarini runs an environmental management system which complies with the UNI EN ISO 14001:2015 standard in order to guarantee company's commitment to continual improvement of its environmental performances.

Colophon

Foscarini SpA
via delle Industrie 27
30020 Marcon /Venezia /Italy
T +39 041 595 3811
foscarini@foscarini.com

Photography:
Gianluca Vassallo
/ White Box Studio
con Francesco Mannironi
e Roberto Verbena

Foscarini Spazio Monforte
Corso Monforte 19
20122 Milano /Italy
T +39 02 870 71320
spaziomonforte@foscarini.com

Massimo Gardone
/ Azimut

Art direction
+ graphic design:
Designwork
Artemio Croatto
Erika Pittis

Foscarini Inc
Foscarini Spazio Soho
20 Greene Street, New York
NY 10013 /USA
T +1 212 247 2218
T +1 212 257 4412 Showroom
foscarini.inc@foscarini.com
spaziosoho@foscarini.com

Colour separation:
Luce, Udine
Made and printed in Italy
by Poligrafiche San Marco,
Cormons
edizione 10.2023

Foscarini Japan K.K.
Tokyo /Japan
foscarini.jpn@foscarini.com

Foscarini International Co., Ltd.
Shanghai, China
foscarini.china@foscarini.com

Azienda certificata
UNI EN ISO 9001
UNI EN ISO 14001

Foscarini

Collezioni

Edizione — 6

33 designer, 26
materiali, 56 finiture,
24 tecnologie, 44
colori, 63 famiglie di
lampade, 227 modelli
diversi.

FOSCARINI